

REGIO V2 R 1 Module

CE UK CA IK08 IP66 

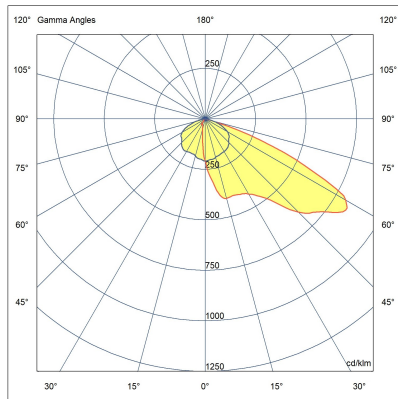

LF8038.551-EN-SLFB-1960-740-EN-C1

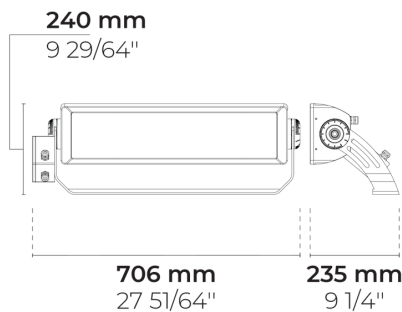

[N]
Narrow

Variant

Light distribution	[N] 15°
Delivered lumens flux	135541 lm
Rated input power	1180 W
Colour temperature	2700 K CRI 80
Luminaire efficacy	115 lm/W
Lamp	504 LED
MacAdam Ellipse	5 SDCM
Lifetime L90B50 (hour)	>52,000
Lifetime L80B50 (hour)	>52,000

Options

Technical information

Mounting	Surface mountable via a bracket
Tilt angle	+110°/-180°
Rotation angle	±4°
Housing	Corrosion resistant, die-cast, marine grade aluminum housing
Finishing	Chromate conversion pretreatment followed by electrostatic powder coating
Fasteners	Stainless steel (AISI 304 / EN 1.4301 grade)
Gasket	Silicone
Glass / Diffusor	Tempered safety glass
Impact protection	IK08
Ingress protection	IP66
Input voltage	220-240V 50/60Hz
Insulation class	Class I
Weight	12.1 kg
Driver	External LED driver
Driver surge protection	10/6 kV
Power factor	> 0.99
Through wiring	Single cable entry
Operating temperature	-40...50°C
Cable	1 m of flexible cable

Accessories (To be ordered separately)

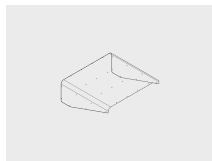

Optical accessories



Visor for REGIO V2 1 Module

100139030

Project name		Type		Quantity	
Date		Note			
LF8038.551-EN-SLFB-1960-740-__-EN-C1-__-__					

Light distribution	Rated input power	Colour temperature	Control	Product colours
[N] Narrow - 15°	[2910] 1180 W	[827] 2700 K CRI 80		[HM3]  Anthracite grey
[MN] Medium narrow - 30°	[2100] 380 W [4280] 580 W [1090] 1480 W	[830] 3000 K CRI 80		[HM4]  Light grey [CC]  Custom colour (Please specify RAL code)
Extras	Accessories (To be ordered separately)			
Consult the factory	Optical accessories			
[UNI] 120-277V 50/60Hz	[100139030] Visor for REGIO V2 1 Module			