

# REGIO 6 Module

CE UK CA IK08 IP66 



LF8032.526-EN-N2-700-840-EN-C1



PHASED-OUT

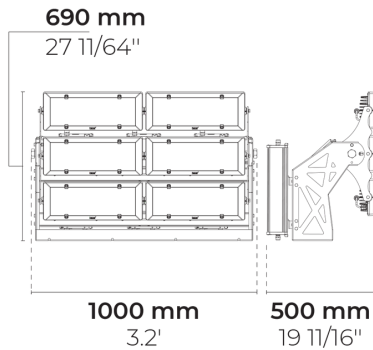

## Variant



<b>Delivered lumens flux</b>	161279 lm
<b>Rated input power</b>	1375 W
<b>Colour temperature</b>	4000 K CRI 80
<b>Luminaire efficacy</b>	117 lm/W
<b>Lamp</b>	648 LED
<b>MacAdam Ellipse</b>	3 SDCM
<b>Lifetime L90B50 (hour)</b>	>102,000
<b>Lifetime L80B50 (hour)</b>	>102,000

## Options

## Technical information

<b>Mounting</b>	Surface mountable via a bracket
<b>Tilt angle</b>	+45°/-45°
<b>Housing</b>	Corrosion resistant, marine grade aluminum housing
<b>Finishing</b>	Chromate conversion pretreatment followed by electrostatic powder coating
<b>Fasteners</b>	Stainless steel (AISI 304 / EN 1.4301 grade)
<b>Gasket</b>	Silicone rubber
<b>Lens / Reflector</b>	PMMA lens with high optical efficiency
<b>Glass / Diffuser</b>	Tempered safety glass
<b>Impact protection</b>	IK08
<b>Ingress protection</b>	IP66
<b>Input voltage</b>	220-240V 50/60Hz
<b>Insulation class</b>	Class I
<b>Weight</b>	58.18 kg
<b>LED module</b>	High power LEDs on metal-core PCB
<b>Driver</b>	External LED driver
<b>Driver surge protection</b>	10/10 kV
<b>Power factor</b>	> 0.99
<b>Through wiring</b>	Single cable entry
<b>Operating temperature</b>	-40...50°C
<b>Cable</b>	1 m of flexible cable
<b>Notes</b>	Please contact the sales department regarding this product's availability.

<b>Project name</b>		<b>Type</b>		<b>Quantity</b>	
<b>Date</b>		<b>Note</b>			
<b>LF8032.526-EN-N2-700-840-__-EN-C1-__-__-__</b>					

Light distribution	Rated input power	Colour temperature	Control	Product colours
<b>[ ]</b> - 26°	<b>[700]</b> 1375 W	<b>[840]</b> 4000 K CRI 80	<b>[ONOFF]</b> On/Off	<b>[HM3]</b>  Anthracite grey
<b>[EL]</b> Elliptical - 15x40°		<b>[827]</b> 2700 K CRI 80	<b>[DALI]</b> DALI	<b>[HM4]</b>  Light grey
<b>[N]</b> Narrow - 22°		<b>[830]</b> 3000 K CRI 80		<b>[CC]</b>  Custom colour (Please specify RAL code)
<b>[MN]</b> Medium narrow - 30°		<b>[740]</b> 4000 K CRI 70		
<b>[M]</b> Medium - 50°		<b>[957]</b> 5700 K CRI 90		
<b>[W]</b> Wide - 111°				
<b>Extras</b>				
<b>Consult the factory</b>				
<b>[UNI]</b> 120-277V 50/60Hz				
<b>Luminaire body options</b>				
<b>[DPC]</b> Double powder coating				