

DOMINO W ML EVO 1 Module

LW7031.681-US

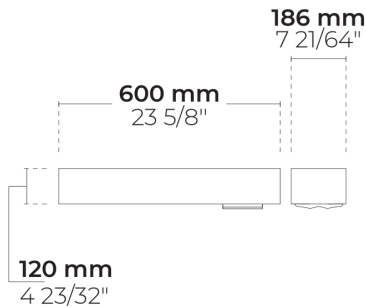

[T2]
Type II - 130x85°

Configurations

Light distribution	[T2] 130x85°
Delivered lumens flux	2909 - 3678 lm
Rated input power	35 W
Color temperature	2700 K CRI 80, 3000 K CRI 80, 4000 K CRI 70, 4000 K CRI 80
BUG rating	B1-U0-G1
Lifetime L90 (hour)	>60, 000
Lifetime L80 (hour)	>60, 000

Options

Control	On/Off, 0-10V
Product colors	







Extras

Connectivity	7 Pin NEMA socket
Consult the factory	Motion sensor
Luminaire body options	Double powder coating

Technical information

Mounting	Surface or wall mountable
Housing	Corrosion resistant, marine grade aluminum housing
Finishing	Chromate conversion pretreatment followed by electrostatic powder coating
Fasteners	Stainless steel (AISI 304 / EN 1.4301 grade)
Gasket	Silicone
Lens / Reflector	High reflectance aluminium coating, multifaceted micro reflector
Glass / Diffusor	Tempered safety glass
Impact protection	IK08
Ingress protection	IP66
Input voltage	120-277V 50/60Hz
Insulation class	Class I
Weight	11.5 lbs
LED module	Multi-chip high power LEDs on metal-core PCB
Driver	Internal LED driver
Driver surge protection	6/6 kV
Power factor	> 0.95
Through wiring	Single power cord entry
Operating temperature	-40...50°C
Power cord	8" of flexible power cord

Project name		Type		Quantity	
Date		Note			
LW7031.681-US- _ _ _ _ _					

Light distribution	Rated input power	Color temperature	Control	Product colors
[T2] Type II - 130x85°	[700] 35 W	[827] 2700 K CRI 80 [830] 3000 K CRI 80 [740] 4000 K CRI 70 [840] 4000 K CRI 80	[ONOFF] On/Off [0-10V] 0-10V	[HM1]  Black [HM2]  Dark gray [HM3]  Anthracite gray [HM4]  Light gray [HM5]  White [HM6]  Bronze [CC]  Custom color (Please specify RAL code)

Extras
Connectivity
[NM7] 7 Pin NEMA socket
Consult the factory
[MS] Motion sensor
Luminaire body options
[DPC] Double powder coating

Configuration code	Light distribution	Delivered lumens flux	Rated input power	Color temperature	Control
LW7031.681-US-T2-700-740	[T2] Type II - 130x85°	3448 lm	35 W	4000 K CRI 70	On/Off, 0-10V
LW7031.681-US-T2-700-827	[T2] Type II - 130x85°	2909 lm	35 W	2700 K CRI 80	On/Off, 0-10V
LW7031.681-US-T2-700-830	[T2] Type II - 130x85°	3678 lm	35 W	4000 K CRI 80	On/Off, 0-10V
LW7031.681-US-T2-700-840	[T2] Type II - 130x85°	2945 lm	35 W	3000 K CRI 80	On/Off, 0-10V