

# PRIFMA W ML EVO 3 Module

LW2042.683-US

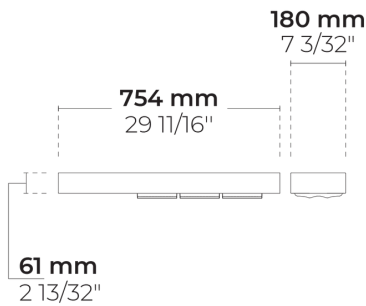

[T2]  
Type II - 130x85°

## Configurations

<b>Light distribution</b>	[T2] 130x85°
<b>Delivered lumens flux</b>	8733 - 11036 lm
<b>Rated input power</b>	104 W
<b>Color temperature</b>	2700 K CRI 80, 3000 K CRI 80, 4000 K CRI 70, 4000 K CRI 80
<b>BUG rating</b>	B2-U0-G2, B2-U0-G1
<b>Lifetime L90 (hour)</b>	>60, 000
<b>Lifetime L80 (hour)</b>	>60, 000

## Options

<b>Control</b>	On/Off, 0-10V
<b>Product colors</b>	

## Extras







<b>Luminaire body options</b>	Double powder coating
-------------------------------	-----------------------

## Technical information

<b>Mounting</b>	Wall mountable
<b>Housing</b>	Corrosion resistant, marine grade aluminum housing
<b>Finishing</b>	Chromate conversion pretreatment followed by electrostatic powder coating
<b>Fasteners</b>	Stainless steel (AISI 304 / EN 1.4301 grade)
<b>Gasket</b>	Liquid silicone
<b>Lens / Reflector</b>	High reflectance aluminium coating, multifaceted micro reflector
<b>Glass / Diffusor</b>	Bio-based, enriched with bisphenol A diffusor
<b>Impact protection</b>	IK08
<b>Ingress protection</b>	IP66
<b>Input voltage</b>	120-277V 50/60Hz
<b>Insulation class</b>	Class I
<b>Weight</b>	14.33 lb
<b>LED module</b>	Multi-chip high power LEDs on metal-core PCB
<b>Driver</b>	Internal LED driver
<b>Driver surge protection</b>	6/6 kV
<b>Power factor</b>	> 0.95
<b>Through wiring</b>	Single power cord entry
<b>Operating temperature</b>	-40...50°C

Project name		Type		Quantity	
Date		Note			

**LW2042.683-US-** \_ \_ \_ \_ \_

Light distribution	Rated input power	Color temperature	Control	Product colors
<b>[T2]</b> Type II - 130x85°	<b>[700]</b> 104 W	<b>[827]</b> 2700 K CRI 80  <b>[830]</b> 3000 K CRI 80  <b>[740]</b> 4000 K CRI 70  <b>[840]</b> 4000 K CRI 80	<b>[ONOFF]</b> On/Off  <b>[0-10V]</b> 0-10V	<b>[HM1]</b>  Black  <b>[HM2]</b>  Dark gray  <b>[HM3]</b>  Anthracite gray  <b>[HM4]</b>  Light gray  <b>[HM5]</b>  White  <b>[HM6]</b>  Bronze  <b>[CC]</b>  Custom color (Please specify RAL code)
<b>Extras</b>				
<b>Luminaire body options</b>				
<b>[DPC]</b> Double powder coating				

<b>Configuration code</b>	<b>Light distribution</b>	<b>Delivered lumens flux</b>	<b>Rated input power</b>	<b>Color temperature</b>	<b>Control</b>
LW2042.683-US-T2-700-740	[T2] Type II - 130x85°	10346 lm	104 W	4000 K CRI 70	On/Off, 0-10V
LW2042.683-US-T2-700-827	[T2] Type II - 130x85°	8733 lm	104 W	2700 K CRI 80	On/Off, 0-10V
LW2042.683-US-T2-700-830	[T2] Type II - 130x85°	11036 lm	104 W	4000 K CRI 80	On/Off, 0-10V
LW2042.683-US-T2-700-840	[T2] Type II - 130x85°	8837 lm	104 W	3000 K CRI 80	On/Off, 0-10V