

PRIFMA W ML EVO 3 Module



IK08 IP66



LW2042.683-EN

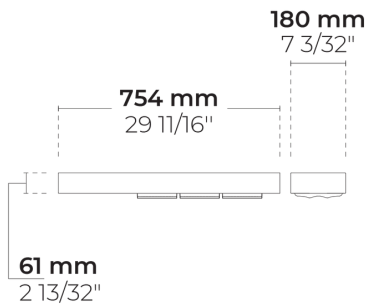

[T2]

Type II, Asymmetric,
Side throw - 130x85°

Variants

Light distribution	[T2] 130x85°
Delivered lumens flux	8733 - 11036 lm
Rated input power	104 W
Colour temperature	2700 K CRI 80, 3000 K CRI 80, 4000 K CRI 70, 4000 K CRI 80
BUG rating	B2-U0-G2, B2-U0-G1
Lifetime L90B50 (hour)	>60, 000
Lifetime L80B50 (hour)	>60, 000

Options

Control

On/Off

Product colours



Extras







Light output	Constant light output
Consult the factory	120-277V 50/60Hz
Luminaire body options	Double powder coating

Technical information

Mounting	Wall mountable
Housing	Corrosion resistant, marine grade aluminum housing
Finishing	Chromate conversion pretreatment followed by electrostatic powder coating
Fasteners	Stainless steel (AISI 304 / EN 1.4301 grade)
Gasket	Liquid silicone
Lens / Reflector	High reflectance aluminium coating, multifaceted micro reflector
Glass / Diffusor	Bio-based, enriched with bisphenol A diffusor
Impact protection	IK08
Ingress protection	IP66
Input voltage	220-240V 50/60Hz
Insulation class	Class I
Weight	6.5 kg
LED module	Multi-chip high power LEDs on metal-core PCB
Driver	Internal LED driver
Driver surge protection	6/6 kV
Power factor	> 0.95
Through wiring	Single cable entry
Operating temperature	-40...50°C

Project name		Type		Quantity	
Date		Note			

LW2042.683-EN-____-____-____-____-____**-EN-C1-**____-____-____-____-____

Light distribution	Rated input power	Colour temperature	Control	Product colours
[T2] Type II, Asymmetric, Side throw - 130x85°	[700] 104 W	[827] 2700 K CRI 80 [830] 3000 K CRI 80 [740] 4000 K CRI 70 [840] 4000 K CRI 80	[ONOFF] On/Off	[HM1]  Black [HM2]  Dark grey [HM3]  Anthracite grey [HM4]  Light grey [HM5]  White [HM6]  Bronze [CC]  Custom colour (Please specify RAL code)

Extras
Light output
[CLO] Constant light output
Consult the factory
[UNI] 120-277V 50/60Hz
Luminaire body options
[DPC] Double powder coating

Variant code	Light distribution	Delivered lumens flux	Rated input power	Colour temperature	Control
LW2042.683-EN-T2-700-740	[T2] Type II, Asymmetric, Side throw - 130x85°	10346 lm	104 W	4000 K CRI 70	On/Off
LW2042.683-EN-T2-700-827	[T2] Type II, Asymmetric, Side throw - 130x85°	8733 lm	104 W	2700 K CRI 80	On/Off
LW2042.683-EN-T2-700-830	[T2] Type II, Asymmetric, Side throw - 130x85°	11036 lm	104 W	4000 K CRI 80	On/Off
LW2042.683-EN-T2-700-840	[T2] Type II, Asymmetric, Side throw - 130x85°	8837 lm	104 W	3000 K CRI 80	On/Off