

GOLEDO-IN 128 LED

LW2037.888-US

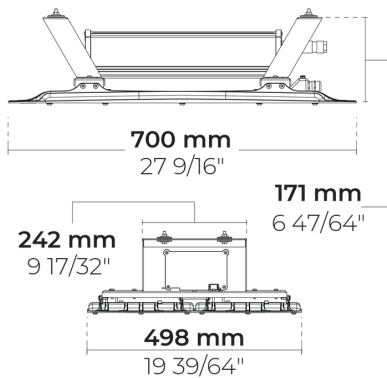

[-2]

[N]
Narrow - NEMA Type
2 - 25°

[M]
Medium - NEMA
Type 4 - 50°

Configurations

Light distribution	[-2], [N] 25°, [M] 50°
Delivered lumens flux	23230 - 30808 lm
Rated input power	188 - 272 W
Color temperature	3000 K CRI 80, 4000 K CRI 80
Lifetime L90 (hour)	>102, 000
Lifetime L80 (hour)	>102, 000

Options

Control	On/Off, 0-10V
Product colors	

Extras



External surge protection	10 kV
Luminaire body options	Double powder coating

Technical information

Mounting	Standard strap connection. Sliding mounting bracket is optional through extra
Housing	Corrosion resistant, die-cast, marine grade aluminum housing
Finishing	Chromate conversion pretreatment followed by electrostatic powder coating
Fasteners	Stainless steel (AISI 304 / EN 1.4301 grade)
Gasket	Silicone
Lens / Reflector	PMMA lens with high optical efficiency
Glass / Diffusor	Tempered safety glass
Impact protection	IK08
Ingress protection	IP66
Input voltage	120-277V 50/60Hz
Insulation class	Class I
Weight	41.34 lbs
LED module	High power LEDs on metal-core PCB
Driver	Internal LED driver
Through wiring	Single power cord entry
Operating temperature	-40...50°C
Power cord	40" of halogen-free power cord

Project name		Type		Quantity	
Date		Note			

LW2037.888-US- _ _ _ _ _

Light distribution	Rated input power	Color temperature	Control	Product colors
[-2] [N] Narrow - NEMA Type 2 - 25° [M] Medium - NEMA Type 4 - 50°	[500] 188 W [700] 272 W	[830] 3000 K CRI 80 [840] 4000 K CRI 80	[ONOFF] On/Off [0-10V] 0-10V	[CC]  Custom color (Please specify RAL code) [7035]  Light gray (RAL 7035)
Extras				
External surge protection				
[SP10] 10 kV				
Luminaire body options				
[DPC] Double powder coating				

Configuration code	Light distribution	Delivered lumens flux	Rated input power	Color temperature	Control
LW2037.888-US-N-500-830	[N] Narrow - NEMA Type 2 - 25°	23800 lm	188 W	3000 K CRI 80	On/Off, 0-10V
LW2037.888-US-N-500-840	[N] Narrow - NEMA Type 2 - 25°	23800 lm	188 W	4000 K CRI 80	On/Off, 0-10V
LW2037.888-US-N-700-830	[N] Narrow - NEMA Type 2 - 25°	30808 lm	272 W	3000 K CRI 80	On/Off, 0-10V
LW2037.888-US-N-700-840	[N] Narrow - NEMA Type 2 - 25°	30808 lm	272 W	4000 K CRI 80	On/Off, 0-10V
LW2037.888-US-M-500-830	[M] Medium - NEMA Type 4 - 50°	23230 lm	188 W	3000 K CRI 80	On/Off, 0-10V
LW2037.888-US-M-500-840	[M] Medium - NEMA Type 4 - 50°	23230 lm	188 W	4000 K CRI 80	On/Off, 0-10V
LW2037.888-US-M-700-830	[M] Medium - NEMA Type 4 - 50°	30066 lm	272 W	3000 K CRI 80	On/Off, 0-10V
LW2037.888-US-M-700-840	[M] Medium - NEMA Type 4 - 50°	30066 lm	272 W	4000 K CRI 80	On/Off, 0-10V
LW2037.888-US-M-350-830	□				On/Off, 0-10V
LW2037.888-US-M-350-840	□				On/Off, 0-10V
LW2037.888-US-N-350-830	□				On/Off, 0-10V
LW2037.888-US-N-350-840	□				On/Off, 0-10V