

GOLEDO-T 32 LED

LT2037.882-EN

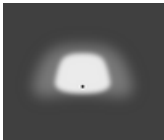

IK08 IP66

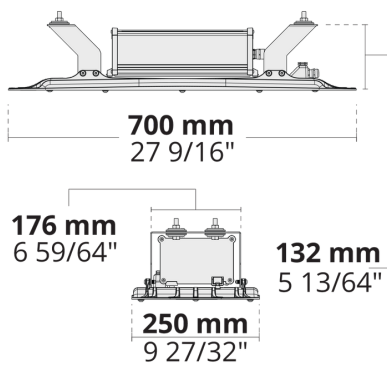

[T-ASYM-A]
Tunnel, Asymmetric,
Type A -

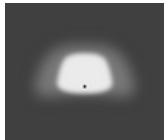

[T-ASYM-B]
Tunnel, Asymmetric,
Type B -

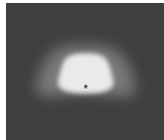

[T-ASYM-C]
Tunnel, Asymmetric,
Type C -



[T-ASYM-D]
Tunnel, Asymmetric,
Type D -



[T-CB-A]
Tunnel, Counter
beam, Type A -



[T-CB-B]
Tunnel, Counter
beam, Type B -

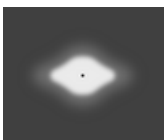

[T-SYM-A]
Tunnel, Symmetric,
Type A -

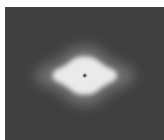

[T-SYM-B]
Tunnel, Symmetric,
Type B -

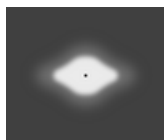

[T-SYM-C]
Tunnel, Symmetric,
Type C -

Variants

Light distribution	[T-ASYM-A] , [T-ASYM-B] , [T-ASYM-C] , [T-ASYM-D] , [T-CB-A] , [T-CB-B] , [T-SYM-A] , [T-SYM-B] , [T-SYM-C] , [T-SYM-D]
Delivered lumens flux	5707 - 10325 lm
Rated input power	33 - 68 W
Colour temperature	3000 K CRI 70, 3000 K CRI 80, 4000 K CRI 70
BUG rating	B4-U0-G4, B3-U0-G3, B5-U0-G4, B4-U0-G3
Lifetime L90B50 (hour)	>102, 000
Lifetime L80B50 (hour)	>102, 000

Options

Control	On/Off, 0-10V, DALI, AutoDIM, StepDIM *
Product colours	

Extras

External surge protection	10 kV
Light output	Constant light output
Consult the factory	Class II, 120-277V 50/60Hz
Luminaire body options	Double powder coating

Technical information

Mounting	Standard strap connection. Sliding mounting bracket is optional through extra
Housing	Corrosion resistant, die-cast, marine grade aluminum housing
Finishing	Chromate conversion pretreatment followed by electrostatic powder coating
Fasteners	Stainless steel (AISI 304 / EN 1.4301 grade)
Gasket	Silicone
Lens / Reflector	PMMA lens with high optical efficiency
Glass / Diffusor	Tempered safety glass
Impact protection	IK08
Ingress protection	IP66
Input voltage	220-240V 50/60Hz
Insulation class	Class I
Weight	8.86 kg
LED module	High power LEDs on metal-core PCB
Driver	Internal LED driver
Driver surge protection	10/6 kV
Power factor	> 0.95
Through wiring	Single cable entry
Operating temperature	-40...50°C
Cable	1 m of halogen-free cable
Notes	This product can be supplied with Insulation class (Class II) upon request. Please contact factory.

HPR Pazarlama A.Ş.
Başkent OSB 22. Cd. No: 2, Malıköy, Temelli,
Sincan, 06909 Ankara, Turkey
+90 312 267 54 30
info@hepergroup.com

HEPER Europe GmbH
Ahornweg 5a, 58675
Hemer, Germany
+49 237 2901 2975
infoEU@hepergroup.com

We reserve the right to change specifications without prior written notice. Edition: 04.04.2024.
For current version visit heperlighting.com. All flux (±7% tolerance) and power values (±10% tolerance) are derived following appropriate IES, CIE, and applicable standards.



[T-SYM-D]

Tunnel, Symmetric,
Type D -

** Please check the specific variant for each control type.*

External surge protection
[SP10] 10 kV
Light output
[CLO] Constant light output
Consult the factory
[C2] Class II
[UNI] 120-277V 50/60Hz
Luminaire body options
[DPC] Double powder coating

Variant code	Light distribution	Delivered lumens flux	Rated input power	Colour temperature	Control
LT2037.882-EN-T-ASYM-A-350-730	[T-ASYM-A] Tunnel, Asymmetric, Type A	8958 lm	50 W	3000 K CRI 70	
LT2037.882-EN-T-ASYM-A-350-740	[T-ASYM-A] Tunnel, Asymmetric, Type A	5852 lm	33 W	4000 K CRI 70	
LT2037.882-EN-T-ASYM-A-350-830	[T-ASYM-A] Tunnel, Asymmetric, Type A			3000 K CRI 80	On/Off, 0-10V, DALI, AutoDIM, StepDIM
LT2037.882-EN-T-ASYM-A-500-730	[T-ASYM-A] Tunnel, Asymmetric, Type A	6825 lm	45 W	3000 K CRI 70	On/Off, 0-10V, DALI, AutoDIM, StepDIM
LT2037.882-EN-T-ASYM-A-500-740	[T-ASYM-A] Tunnel, Asymmetric, Type A	7630 lm	47 W	4000 K CRI 70	On/Off, 0-10V, DALI, AutoDIM, StepDIM
LT2037.882-EN-T-ASYM-A-700-730	[T-ASYM-A] Tunnel, Asymmetric, Type A	9480 lm	68 W	3000 K CRI 70	On/Off, 0-10V, DALI, AutoDIM, StepDIM
LT2037.882-EN-T-ASYM-A-700-740	[T-ASYM-A] Tunnel, Asymmetric, Type A	10265 lm	68 W	4000 K CRI 70	On/Off, 0-10V, DALI, AutoDIM, StepDIM
LT2037.882-EN-T-ASYM-B-350-730	[T-ASYM-B] Tunnel, Asymmetric, Type B	8855 lm	50 W	3000 K CRI 70	
LT2037.882-EN-T-ASYM-B-350-740	[T-ASYM-B] Tunnel, Asymmetric, Type B	5903 lm	33 W	4000 K CRI 70	
LT2037.882-EN-T-ASYM-B-500-730	[T-ASYM-B] Tunnel, Asymmetric, Type B	6685 lm	45 W	3000 K CRI 70	On/Off, 0-10V, DALI, AutoDIM, StepDIM
LT2037.882-EN-T-ASYM-B-500-740	[T-ASYM-B] Tunnel, Asymmetric, Type B	7470 lm	46 W	4000 K CRI 70	On/Off, 0-10V, DALI, AutoDIM, StepDIM
LT2037.882-EN-T-ASYM-B-700-730	[T-ASYM-B] Tunnel, Asymmetric, Type B	9290 lm	68 W	3000 K CRI 70	On/Off, 0-10V, DALI, AutoDIM, StepDIM
LT2037.882-EN-T-ASYM-B-700-740	[T-ASYM-B] Tunnel, Asymmetric, Type B	10230 lm	68 W	4000 K CRI 70	On/Off, 0-10V, DALI, AutoDIM, StepDIM
LT2037.882-EN-T-ASYM-C-350-730	[T-ASYM-C] Tunnel, Asymmetric, Type C	8947 lm	50 W	3000 K CRI 70	
LT2037.882-EN-T-ASYM-C-350-740	[T-ASYM-C] Tunnel, Asymmetric, Type C	5964 lm	33 W	4000 K CRI 70	
LT2037.882-EN-T-ASYM-C-500-730	[T-ASYM-C] Tunnel, Asymmetric, Type C	6855 lm	45 W	3000 K CRI 70	On/Off, 0-10V, DALI, AutoDIM, StepDIM
LT2037.882-EN-T-ASYM-C-500-740	[T-ASYM-C] Tunnel, Asymmetric, Type C	7665 lm	47 W	4000 K CRI 70	On/Off, 0-10V, DALI, AutoDIM, StepDIM
LT2037.882-EN-T-ASYM-C-700-730	[T-ASYM-C] Tunnel, Asymmetric, Type C	9525 lm	68 W	3000 K CRI 70	On/Off, 0-10V, DALI, AutoDIM, StepDIM
LT2037.882-EN-T-ASYM-C-700-740	[T-ASYM-C] Tunnel, Asymmetric, Type C	10320 lm	68 W	4000 K CRI 70	On/Off, 0-10V, DALI, AutoDIM, StepDIM
LT2037.882-EN-T-ASYM-D-350-730	[T-ASYM-D] Tunnel, Asymmetric, Type D	8715 lm	50 W	3000 K CRI 70	

HPR Pazarlama A.Ş.

Başkent OSB 22. Cd. No: 2, Malıköy, Temelli,
Sincan, 06909 Ankara, Turkey
+90 312 267 54 30
info@hepergroup.com

HEPER Europe GmbH

Ahornweg 5a, 58675
Hemer, Germany
+49 237 2901 2975
infoEU@hepergroup.com

We reserve the right to change specifications without prior written notice. Edition: 04.04.2024.
For current version visit heperlighting.com. All flux ($\pm 7\%$ tolerance) and power values ($\pm 10\%$ tolerance) are derived following appropriate IES, CIE, and applicable standards.

LT2037.882-EN-T-ASYM-D-350-740	[T-ASYM-D] Tunnel, Asymmetric, Type D	5810 lm	33 W	4000 K CRI 70	
LT2037.882-EN-T-ASYM-D-500-730	[T-ASYM-D] Tunnel, Asymmetric, Type D	6855 lm	45 W	3000 K CRI 70	On/Off, 0-10V, DALI, AutoDIM, StepDIM
LT2037.882-EN-T-ASYM-D-500-740	[T-ASYM-D] Tunnel, Asymmetric, Type D	7350 lm	46 W	4000 K CRI 70	On/Off, 0-10V, DALI, AutoDIM, StepDIM
LT2037.882-EN-T-ASYM-D-700-730	[T-ASYM-D] Tunnel, Asymmetric, Type D	9525 lm	68 W	3000 K CRI 70	On/Off, 0-10V, DALI, AutoDIM, StepDIM
LT2037.882-EN-T-ASYM-D-700-740	[T-ASYM-D] Tunnel, Asymmetric, Type D	10045 lm	68 W	4000 K CRI 70	On/Off, 0-10V, DALI, AutoDIM, StepDIM
LT2037.882-EN-T-CB-A-350-730	[T-CB-A] Tunnel, Counter beam, Type A	8884 lm	50 W	3000 K CRI 70	
LT2037.882-EN-T-CB-A-350-740	[T-CB-A] Tunnel, Counter beam, Type A	5923 lm	33 W	4000 K CRI 70	
LT2037.882-EN-T-CB-A-350-830	[T-CB-A] Tunnel, Counter beam, Type A			3000 K CRI 80	On/Off, 0-10V, DALI, AutoDIM, StepDIM
LT2037.882-EN-T-CB-A-500-730	[T-CB-A] Tunnel, Counter beam, Type A	6810 lm	45 W	3000 K CRI 70	On/Off, 0-10V, DALI, AutoDIM, StepDIM
LT2037.882-EN-T-CB-A-500-740	[T-CB-A] Tunnel, Counter beam, Type A	7615 lm	46 W	4000 K CRI 70	On/Off, 0-10V, DALI, AutoDIM, StepDIM
LT2037.882-EN-T-CB-A-700-730	[T-CB-A] Tunnel, Counter beam, Type A	9460 lm	68 W	3000 K CRI 70	On/Off, 0-10V, DALI, AutoDIM, StepDIM
LT2037.882-EN-T-CB-A-700-740	[T-CB-A] Tunnel, Counter beam, Type A	10325 lm	68 W	4000 K CRI 70	On/Off, 0-10V, DALI, AutoDIM, StepDIM
LT2037.882-EN-T-CB-B-350-730	[T-CB-B] Tunnel, Counter beam, Type B	8612 lm	50 W	3000 K CRI 70	
LT2037.882-EN-T-CB-B-350-740	[T-CB-B] Tunnel, Counter beam, Type B	5741 lm	33 W	4000 K CRI 70	
LT2037.882-EN-T-CB-B-500-730	[T-CB-B] Tunnel, Counter beam, Type B	6595 lm	45 W	3000 K CRI 70	On/Off, 0-10V, DALI, AutoDIM, StepDIM
LT2037.882-EN-T-CB-B-500-740	[T-CB-B] Tunnel, Counter beam, Type B	7375 lm	46 W	4000 K CRI 70	On/Off, 0-10V, DALI, AutoDIM, StepDIM
LT2037.882-EN-T-CB-B-700-730	[T-CB-B] Tunnel, Counter beam, Type B	9165 lm	68 W	3000 K CRI 70	On/Off, 0-10V, DALI, AutoDIM, StepDIM
LT2037.882-EN-T-CB-B-700-740	[T-CB-B] Tunnel, Counter beam, Type B	9955 lm	68 W	4000 K CRI 70	On/Off, 0-10V, DALI, AutoDIM, StepDIM
LT2037.882-EN-T-SYM-A-350-730	[T-SYM-A] Tunnel, Symmetric, Type A	8783 lm	50 W	3000 K CRI 70	
LT2037.882-EN-T-SYM-A-350-740	[T-SYM-A] Tunnel, Symmetric, Type A	5856 lm	33 W	4000 K CRI 70	
LT2037.882-EN-T-SYM-A-350-830	[T-SYM-A] Tunnel, Symmetric, Type A			3000 K CRI 80	On/Off, 0-10V, DALI, AutoDIM, StepDIM

HPR Pazarlama A.Ş.

Başkent OSB 22. Cd. No: 2, Malıköy, Temelli,
Sincan, 06909 Ankara, Turkey
+90 312 267 54 30
info@hepergroup.com

HEPER Europe GmbH

Ahornweg 5a, 58675
Hemer, Germany
+49 237 2901 2975
infoEU@hepergroup.com

We reserve the right to change specifications without prior written notice. Edition: 04.04.2024.
For current version visit heperlighting.com. All flux ($\pm 7\%$ tolerance) and power values ($\pm 10\%$ tolerance) are derived following appropriate IES, CIE, and applicable standards.

LT2037.882-EN-T-SYM-A-500-730	[T-SYM-A] Tunnel, Symmetric, Type A	6725 lm	45 W	3000 K CRI 70	On/Off, 0-10V, DALI, AutoDIM, StepDIM
LT2037.882-EN-T-SYM-A-500-740	[T-SYM-A] Tunnel, Symmetric, Type A	7515 lm	46 W	4000 K CRI 70	On/Off, 0-10V, DALI, AutoDIM, StepDIM
LT2037.882-EN-T-SYM-A-700-730	[T-SYM-A] Tunnel, Symmetric, Type A	9340 lm	68 W	3000 K CRI 70	On/Off, 0-10V, DALI, AutoDIM, StepDIM
LT2037.882-EN-T-SYM-A-700-740	[T-SYM-A] Tunnel, Symmetric, Type A	10195 lm	68 W	4000 K CRI 70	On/Off, 0-10V, DALI, AutoDIM, StepDIM
LT2037.882-EN-T-SYM-B-350-730	[T-SYM-B] Tunnel, Symmetric, Type B	8778 lm	50 W	3000 K CRI 70	
LT2037.882-EN-T-SYM-B-350-740	[T-SYM-B] Tunnel, Symmetric, Type B	5852 lm	33 W	4000 K CRI 70	
LT2037.882-EN-T-SYM-B-500-730	[T-SYM-B] Tunnel, Symmetric, Type B	6650 lm	45 W	3000 K CRI 70	On/Off, 0-10V, DALI, AutoDIM, StepDIM
LT2037.882-EN-T-SYM-B-500-740	[T-SYM-B] Tunnel, Symmetric, Type B	7435 lm	46 W	4000 K CRI 70	On/Off, 0-10V, DALI, AutoDIM, StepDIM
LT2037.882-EN-T-SYM-B-700-730	[T-SYM-B] Tunnel, Symmetric, Type B	9235 lm	68 W	3000 K CRI 70	On/Off, 0-10V, DALI, AutoDIM, StepDIM
LT2037.882-EN-T-SYM-B-700-740	[T-SYM-B] Tunnel, Symmetric, Type B	10125 lm	68 W	4000 K CRI 70	On/Off, 0-10V, DALI, AutoDIM, StepDIM
LT2037.882-EN-T-SYM-C-350-730	[T-SYM-C] Tunnel, Symmetric, Type C	8881 lm	50 W	3000 K CRI 70	
LT2037.882-EN-T-SYM-C-350-740	[T-SYM-C] Tunnel, Symmetric, Type C	5921 lm	33 W	4000 K CRI 70	
LT2037.882-EN-T-SYM-C-500-730	[T-SYM-C] Tunnel, Symmetric, Type C	6760 lm	45 W	3000 K CRI 70	On/Off, 0-10V, DALI, AutoDIM, StepDIM
LT2037.882-EN-T-SYM-C-500-740	[T-SYM-C] Tunnel, Symmetric, Type C	7555 lm	46 W	4000 K CRI 70	On/Off, 0-10V, DALI, AutoDIM, StepDIM
LT2037.882-EN-T-SYM-C-700-730	[T-SYM-C] Tunnel, Symmetric, Type C	9390 lm	68 W	3000 K CRI 70	On/Off, 0-10V, DALI, AutoDIM, StepDIM
LT2037.882-EN-T-SYM-C-700-740	[T-SYM-C] Tunnel, Symmetric, Type C	10275 lm	68 W	4000 K CRI 70	On/Off, 0-10V, DALI, AutoDIM, StepDIM
LT2037.882-EN-T-SYM-D-350-730	[T-SYM-D] Tunnel, Symmetric, Type D	8560 lm	50 W	3000 K CRI 70	
LT2037.882-EN-T-SYM-D-350-740	[T-SYM-D] Tunnel, Symmetric, Type D	5707 lm	33 W	4000 K CRI 70	
LT2037.882-EN-T-SYM-D-500-730	[T-SYM-D] Tunnel, Symmetric, Type D	6520 lm	45 W	3000 K CRI 70	On/Off, 0-10V, DALI, AutoDIM, StepDIM
LT2037.882-EN-T-SYM-D-500-740	[T-SYM-D] Tunnel, Symmetric, Type D	7295 lm	46 W	4000 K CRI 70	On/Off, 0-10V, DALI, AutoDIM, StepDIM

HPR Pazarlama A.Ş.

Başkent OSB 22. Cd. No: 2, Malıköy, Temelli,
Sincan, 06909 Ankara, Turkey
+90 312 267 54 30
info@hepergroup.com

HEPER Europe GmbH

Ahornweg 5a, 58675
Hemer, Germany
+49 237 2901 2975
infoEU@hepergroup.com

We reserve the right to change specifications without prior written notice. Edition: 04.04.2024.
For current version visit heperlighting.com. All flux (±%7 tolerance) and power values (±%10 tolerance) are derived following appropriate IES, CIE, and applicable standards.

LT2037.882-EN-T-SYM-D-700-730	[T-SYM-D] Tunnel, Symmetric, Type D	9060 lm	68 W	3000 K CRI 70	On/Off, 0-10V, DALI, AutoDIM, StepDIM
LT2037.882-EN-T-SYM-D-700-740	[T-SYM-D] Tunnel, Symmetric, Type D	9875 lm	68 W	4000 K CRI 70	On/Off, 0-10V, DALI, AutoDIM, StepDIM