

MINIKA 4x90°

LR9014.515-4x90-US

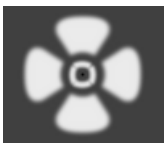
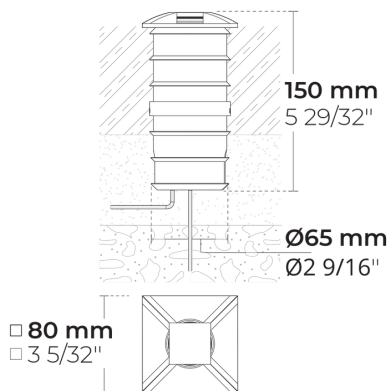

[C4-90]

Controlled, 4 sides,
4x90° - 270x50°

Configurations

Light distribution	[C4-90] 270x50°
Delivered lumens flux	23 - 27 lm
Rated input power	1.7 W
Color temperature	2700 K CRI 80, 3000 K CRI 80, 4000 K CRI 70, 4000 K CRI 80
Lifetime L90 (hour)	>102,000
Lifetime L80 (hour)	>102,000

Options

Control	On/Off
Product colors	

Technical information

Mounting	Ground recessed mountable
Housing	Corrosion resistant stainless steel housing
Finishing	Chromate conversion pretreatment followed by electrostatic powder coating
Fasteners	Stainless steel (AISI 304 / EN 1.4301 grade)
Gasket	Silicone rubber
Lens / Reflector	PMMA lens with high optical efficiency
Glass / Diffusor	Custom Design PMMA Diffusor
Impact protection	IK10
Ingress protection	IP67
Input voltage	120-277V 50/60Hz
Insulation class	Class I
Weight	1.45 lbs
LED module	High power LEDs on metal-core PCB
Driver	Internal LED driver
Driver surge protection	3/3 kV
Power factor	> 0.40
Through wiring	Single power cord entry
Operating temperature	-40...50°C
Power cord	12" of rubber-sheathed power cord

Accessories (Included)

Mounting accessories

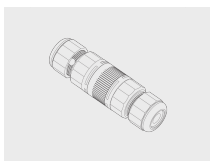

Connector set - 5-pole

141407400

Mounting accessories









Plastic case for MINIMO/MINIKA

160401101

Project name		Type		Quantity	
Date		Note			

LR9014.515-4x90-US-__-__-__-__-__

Light distribution	Rated input power	Color temperature	Control	Product colors
[C4-90] Controlled, 4 sides, 4x90° - 270x50°	[350] 1.7 W	[827] 2700 K CRI 80 [830] 3000 K CRI 80 [740] 4000 K CRI 70 [840] 4000 K CRI 80	[ONOFF] On/Off	[HM1]  Black [HM2]  Dark gray [HM3]  Anthracite gray [HM4]  Light gray [HM5]  White [HM6]  Bronze [CC]  Custom color (Please specify RAL code)

Accessories
(Included)

Mounting accessories

[141407400]
Connector set - 5-pole

[160401101]
Plastic case for
MINIMO/MINIKA

Configuration code	Light distribution	Delivered lumens flux	Rated input power	Color temperature	Control
LR9014.515-4x90-US-C4-350-740	[C4-90] Controlled, 4 sides, 4x90° - 270x50°	27 lm	1.7 W	4000 K CRI 70	On/Off
LR9014.515-4x90-US-C4-350-827	[C4-90] Controlled, 4 sides, 4x90° - 270x50°	23 lm	1.7 W	2700 K CRI 80	On/Off
LR9014.515-4x90-US-C4-350-830	[C4-90] Controlled, 4 sides, 4x90° - 270x50°	23 lm	1.7 W	3000 K CRI 80	On/Off
LR9014.515-4x90-US-C4-350-840	[C4-90] Controlled, 4 sides, 4x90° - 270x50°	23 lm	1.7 W	4000 K CRI 80	On/Off