

# MINIKA 4x90°

LR9014.515-4x90-EN

CE UK CA IK10 IP67 

**heper**<sup>+</sup>

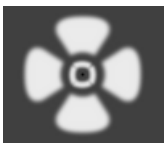
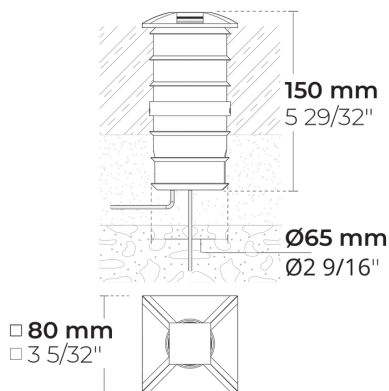

[C4-90]

Controlled, 4 sides,  
4x90° - 270x50°

## Variants

<b>Light distribution</b>	[C4-90] 270x50°
<b>Delivered lumens flux</b>	23 - 27 lm
<b>Rated input power</b>	1.7 W
<b>Colour temperature</b>	2700 K CRI 80, 3000 K CRI 80, 4000 K CRI 70, 4000 K CRI 80
<b>Lifetime L90B50 (hour)</b>	>102,000
<b>Lifetime L80B50 (hour)</b>	>102,000

## Options

<b>Control</b>	On/Off
<b>Product colours</b>	

## Extras

<b>Consult the factory</b>	120-277V 50/60Hz
<b>Luminaire body options</b>	Stainless steel housing

## Technical information

<b>Mounting</b>	Ground recessed mountable
<b>Housing</b>	Corrosion resistant, marine grade aluminum housing
<b>Finishing</b>	Chromate conversion pretreatment followed by electrostatic powder coating
<b>Fasteners</b>	Stainless steel (AISI 304 / EN 1.4301 grade)
<b>Gasket</b>	Silicone rubber
<b>Lens / Reflector</b>	PMMA lens with high optical efficiency
<b>Glass / Diffusor</b>	Custom Design PMMA Diffusor
<b>Impact protection</b>	IK10
<b>Ingress protection</b>	IP67
<b>Input voltage</b>	220-240V 50/60Hz
<b>Insulation class</b>	Class I
<b>Weight</b>	0.66 kg
<b>LED module</b>	High power LEDs on metal-core PCB
<b>Driver</b>	Internal LED driver
<b>Driver surge protection</b>	1/1 kV
<b>Power factor</b>	> 0.60
<b>Through wiring</b>	Single cable entry
<b>Operating temperature</b>	-40...50°C
<b>Cable</b>	0.3 m of rubber-sheathed cable

## Accessories (Included)

Mounting accessories

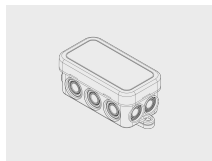

**Junction Box for  
MINIMO-MINIKA**

141901034

Mounting accessories



**Plastic case for  
MINIMO/MINIKA**

160401101

## Accessories (To be ordered separately)

Mounting accessories

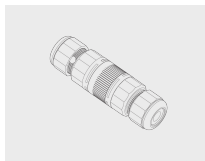







**Connector set - 5-  
pole**

141407400

Project name		Type		Quantity	
Date		Note			

**LR9014.515-4x90-EN-\_\_-\_\_-\_\_-\_\_-EN-C1-\_\_-\_\_-\_\_**

Light distribution	Rated input power	Colour temperature	Control	Product colours
<b>[C4-90]</b> Controlled, 4 sides, 4x90° - 270x50°	<b>[350]</b> 1.7 W	<b>[827]</b> 2700 K CRI 80  <b>[830]</b> 3000 K CRI 80  <b>[740]</b> 4000 K CRI 70  <b>[840]</b> 4000 K CRI 80	<b>[ONOFF]</b> On/Off	<b>[HM1]</b>  Black  <b>[HM2]</b>  Dark grey  <b>[HM3]</b>  Anthracite grey  <b>[HM4]</b>  Light grey  <b>[HM5]</b>  White  <b>[HM6]</b>  Bronze  <b>[CC]</b>  Custom colour (Please specify RAL code)
<b>Extras</b>	<b>Accessories (Included)</b>	<b>Accessories (To be ordered separately)</b>		
<b>Consult the factory</b>	<b>Mounting accessories</b>	<b>Mounting accessories</b>		
<b>[UNI]</b> 120-277V 50/60Hz	<b>[141901034]</b> Junction Box for MINIMO-MINIKA	<b>[141407400]</b> Connector set - 5-pole		
<b>Luminaire body options</b>	<b>[160401101]</b> Plastic case for MINIMO/MINIKA			
<b>[SS]</b> Stainless steel housing				

Variant code	Light distribution	Delivered lumens flux	Rated input power	Colour temperature	Control
LR9014.515-4x90-EN-C4-350-740	[C4-90] Controlled, 4 sides, 4x90° - 270x50°	27 lm	1.7 W	4000 K CRI 70	On/Off
LR9014.515-4x90-EN-C4-350-827	[C4-90] Controlled, 4 sides, 4x90° - 270x50°	23 lm	1.7 W	2700 K CRI 80	On/Off
LR9014.515-4x90-EN-C4-350-830	[C4-90] Controlled, 4 sides, 4x90° - 270x50°	23 lm	1.7 W	3000 K CRI 80	On/Off
LR9014.515-4x90-EN-C4-350-840	[C4-90] Controlled, 4 sides, 4x90° - 270x50°	23 lm	1.7 W	4000 K CRI 80	On/Off