

# MINIKA 3x90°

LR9014.515-3x90-US

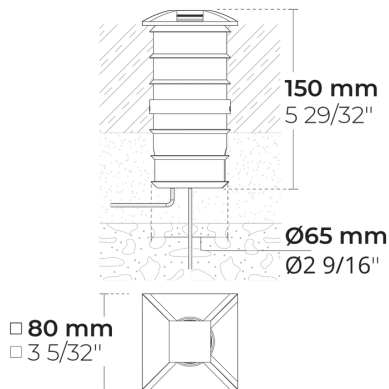

[C3-90]

Controlled, 3 sides,  
3x90° - 270x50°

## Configurations

<b>Light distribution</b>	[C3-90] 270x50°
<b>Delivered lumens flux</b>	19 - 22 lm
<b>Rated input power</b>	1.7 W
<b>Color temperature</b>	2700 K CRI 80, 3000 K CRI 80, 4000 K CRI 70, 4000 K CRI 80
<b>Lifetime L90 (hour)</b>	>102,000
<b>Lifetime L80 (hour)</b>	>102,000

## Options

<b>Control</b>	On/Off
<b>Product colors</b>	

## Technical information

<b>Mounting</b>	Ground recessed mountable
<b>Housing</b>	Corrosion resistant stainless steel housing
<b>Finishing</b>	Chromate conversion pretreatment followed by electrostatic powder coating
<b>Fasteners</b>	Stainless steel (AISI 304 / EN 1.4301 grade)
<b>Gasket</b>	Silicone rubber
<b>Lens / Reflector</b>	PMMA lens with high optical efficiency
<b>Glass / Diffusor</b>	Custom Design PMMA Diffusor
<b>Impact protection</b>	IK10
<b>Ingress protection</b>	IP67
<b>Input voltage</b>	120-277V 50/60Hz
<b>Insulation class</b>	Class I
<b>Weight</b>	1.45 lbs
<b>LED module</b>	High power LEDs on metal-core PCB
<b>Driver</b>	Internal LED driver
<b>Driver surge protection</b>	3/3 kV
<b>Power factor</b>	> 0.40
<b>Through wiring</b>	Single power cord entry
<b>Operating temperature</b>	-40...50°C
<b>Power cord</b>	12" of rubber-sheathed power cord

## Accessories (Included)

---

### Mounting accessories

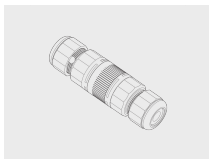







### Connector set - 5-pole

141407400

Project name		Type		Quantity	
Date		Note			

**LR9014.515-3x90-US-\_\_-\_\_-\_\_-\_\_-\_\_**

Light distribution	Rated input power	Color temperature	Control	Product colors
<b>[C3-90]</b> Controlled, 3 sides, 3x90° - 270x50°	<b>[350]</b> 1.7 W	<b>[827]</b> 2700 K CRI 80  <b>[830]</b> 3000 K CRI 80  <b>[740]</b> 4000 K CRI 70  <b>[840]</b> 4000 K CRI 80	<b>[ONOFF]</b> On/Off	<b>[HM1]</b>  Black  <b>[HM2]</b>  Dark gray  <b>[HM3]</b>  Anthracite gray  <b>[HM4]</b>  Light gray  <b>[HM5]</b>  White  <b>[HM6]</b>  Bronze  <b>[CC]</b>  Custom color (Please specify RAL code)

**Accessories**  
*(Included)*

**Mounting accessories**

**[141407400]**  
Connector set - 5-pole

Configuration code	Light distribution	Delivered lumens flux	Rated input power	Color temperature	Control
LR9014.515-3x90-US-C3-350-740	[C3-90] Controlled, 3 sides, 3x90° - 270x50°	22 lm	1.7 W	4000 K CRI 70	On/Off
LR9014.515-3x90-US-C3-350-827	[C3-90] Controlled, 3 sides, 3x90° - 270x50°	19 lm	1.7 W	2700 K CRI 80	On/Off
LR9014.515-3x90-US-C3-350-830	[C3-90] Controlled, 3 sides, 3x90° - 270x50°	19 lm	1.7 W	3000 K CRI 80	On/Off
LR9014.515-3x90-US-C3-350-840	[C3-90] Controlled, 3 sides, 3x90° - 270x50°	19 lm	1.7 W	4000 K CRI 80	On/Off