

MINIKA 3x90°

LR9014.515-3x90-EN

CE UK CA IK10 IP67 

heper⁺

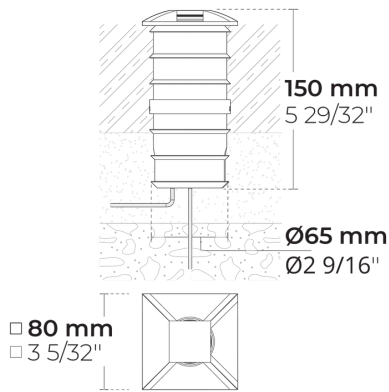

[C3-90]

Controlled, 3 sides,
3x90° - 270x50°

Variants

Light distribution	[C3-90] 270x50°
Delivered lumens flux	19 - 22 lm
Rated input power	1.7 W
Colour temperature	2700 K CRI 80, 3000 K CRI 80, 4000 K CRI 70, 4000 K CRI 80
Lifetime L90B50 (hour)	>102,000
Lifetime L80B50 (hour)	>102,000

Options

Control	On/Off
Product colours	

Extras

Consult the factory	120-277V 50/60Hz
Luminaire body options	Stainless steel housing

Technical information

Mounting	Ground recessed mountable
Housing	Corrosion resistant, marine grade aluminum housing
Finishing	Chromate conversion pretreatment followed by electrostatic powder coating
Fasteners	Stainless steel (AISI 304 / EN 1.4301 grade)
Gasket	Silicone rubber
Lens / Reflector	PMMA lens with high optical efficiency
Glass / Diffusor	Custom Design PMMA Diffusor
Impact protection	IK10
Ingress protection	IP67
Input voltage	220-240V 50/60Hz
Insulation class	Class I
Weight	0.66 kg
LED module	High power LEDs on metal-core PCB
Driver	Internal LED driver
Driver surge protection	1/1 kV
Power factor	> 0.60
Through wiring	Single cable entry
Operating temperature	-40...50°C
Cable	0.3 m of rubber-sheathed cable

Accessories (Included)

Mounting accessories

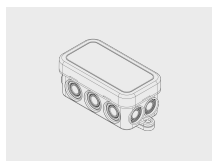

**Junction Box for
MINIMO-MINIKA**

141901034

Mounting accessories



**Plastic case for
MINIMO/MINIKA**

160401101

Accessories (To be ordered separately)

Mounting accessories

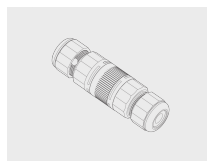







**Connector set - 5-
pole**

141407400

Project name		Type		Quantity	
Date		Note			

LR9014.515-3x90-EN-__-__-__-__-EN-C1-__-__-__

Light distribution	Rated input power	Colour temperature	Control	Product colours
[C3-90] Controlled, 3 sides, 3x90° - 270x50°	[350] 1.7 W	[827] 2700 K CRI 80 [830] 3000 K CRI 80 [740] 4000 K CRI 70 [840] 4000 K CRI 80	[ONOFF] On/Off	[HM1]  Black [HM2]  Dark grey [HM3]  Anthracite grey [HM4]  Light grey [HM5]  White [HM6]  Bronze [CC]  Custom colour (Please specify RAL code)
Extras	Accessories (Included)	Accessories (To be ordered separately)		
Consult the factory	Mounting accessories	Mounting accessories		
[UNI] 120-277V 50/60Hz	[141901034] Junction Box for MINIMO-MINIKA	[141407400] Connector set - 5-pole		
Luminaire body options	[160401101] Plastic case for MINIMO/MINIKA			
[SS] Stainless steel housing				

Variant code	Light distribution	Delivered lumens flux	Rated input power	Colour temperature	Control
LR9014.515-3x90-EN-C3-350-740	[C3-90] Controlled, 3 sides, 3x90° - 270x50°	22 lm	1.7 W	4000 K CRI 70	On/Off
LR9014.515-3x90-EN-C3-350-827	[C3-90] Controlled, 3 sides, 3x90° - 270x50°	19 lm	1.7 W	2700 K CRI 80	On/Off
LR9014.515-3x90-EN-C3-350-830	[C3-90] Controlled, 3 sides, 3x90° - 270x50°	19 lm	1.7 W	3000 K CRI 80	On/Off
LR9014.515-3x90-EN-C3-350-840	[C3-90] Controlled, 3 sides, 3x90° - 270x50°	19 lm	1.7 W	4000 K CRI 80	On/Off