

PIRUS, 360°, 2 Module

LP4075.844-EN

CE UK CA IK08 IP65 

heper⁺

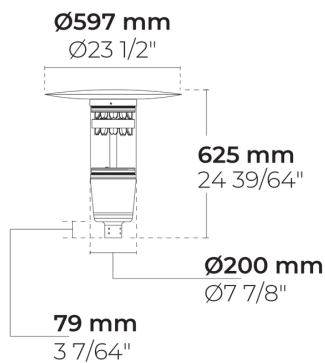

[SYM]
Symmetric - 118°

Variants

Light distribution	[SYM] 118°
Delivered lumens flux	4035 - 4940 lm
Rated input power	52 W
Colour temperature	2700 K CRI 80, 3000 K CRI 80, 4000 K CRI 70, 4000 K CRI 80
BUG rating	B2-U0-G1
Lifetime L90B50 (hour)	>60, 000
Lifetime L80B50 (hour)	>60, 000

Options

Control	On/Off, DALI, AutoDIM, StepDIM
Product colours	

Extras

Consult the factory	120-277V 50/60Hz
----------------------------	------------------

Technical information

Mounting	Direct pole top mounting for 60mm top diameter
Housing	Corrosion resistant, marine grade aluminum housing
Finishing	Chromate conversion pretreatment followed by electrostatic powder coating
Fasteners	Stainless steel (AISI 304 / EN 1.4301 grade)
Gasket	Silicone
Glass / Diffusor	UV stable, bio-based polycarbonate diffusor
Impact protection	IK08
Ingress protection	IP65
Input voltage	220-240V 50/60Hz
Insulation class	Class I
Wind catching area (EPA)	0.14 m ²
Weight	8.59 kg
Driver	Internal LED driver
Driver surge protection	10/6 kV
Power factor	> 0.95
Through wiring	Single cable entry
Operating temperature	-40...50°C
Cable	0.5 m of flexible cable

HPR Pazarlama A.Ş.
Başkent OSB 22. Cd. No: 2, Malıköy, Temelli,
Sincan, 06909 Ankara, Turkey
+90 312 267 54 30
info@hepergroup.com

HEPER Europe GmbH
Ahornweg 5a, 58675
Hemer, Germany
+49 237 2901 2975
infoEU@hepergroup.com

We reserve the right to change specifications without prior written notice. Edition: 23.02.2024.
For current version visit heperlighting.com. All flux (±%7 tolerance) and power values (±%10 tolerance) are derived following appropriate IES, CIE, and applicable standards.

Poles (To be ordered separately)

Conical aluminum poles with flange plate



Product code	Height	Diameter / Dimensions	Spigot diameter
PAFK.D114	3m, 4m, 5m m	Ø114mm	Ø60mm, Ø76mm mm
PAFK.D122	4m, 5m, 6m m	Ø122mm	Ø60mm, Ø76mm mm
PAFK.D148	6m, 7m, 8m m	Ø148mm	Ø60mm, Ø76mm mm
PAFK.D165	6m, 7m, 8m, 9m m	Ø165mm	Ø76mm, Ø90mm mm
PAFK.D180	10m, 8m, 9m m	Ø180mm	Ø76mm, Ø90mm mm
PAFK.D200	10m, 11m, 12m m	Ø200mm	Ø76mm, Ø90mm mm

Conical aluminum poles with embedded base









Product code	Height	Diameter / Dimensions	Spigot diameter
PABK.D114	3m, 4m, 5m m	Ø114mm	Ø60mm, Ø76mm mm
PABK.D122	4m, 5m, 6m, 7m m	Ø122mm	Ø60mm, Ø76mm mm
PABK.D148	6m, 7m, 8m m	Ø148mm	Ø60mm, Ø76mm mm
PABK.D165	6m, 7m, 8m, 9m m	Ø165mm	Ø76mm, Ø90mm mm
PABK.D180	10m, 8m, 9m m	Ø180mm	Ø76mm, Ø90mm mm
PABK.D200	10m, 11m, 12m m	Ø200mm	Ø76mm, Ø90mm mm

Cylindrical aluminum poles with flange plate



Product code	Height	Diameter / Dimensions	Spigot diameter
PAFC.D114	3m, 4m, 5m m	Ø114mm	Ø114mm mm
PAFC.D122	3m, 4m, 5m, 6m m	Ø122mm	Ø122mm mm
PAFC.D148	6m, 7m, 8m m	Ø148mm	Ø148mm mm
PAFC.D165	6m, 7m, 8m, 9m m	Ø165mm	Ø165mm mm

Project name		Type		Quantity	
Date		Note			
LP4075.844-EN-__-__-__-__-EN-C1-__-__					

Light distribution	Rated input power	Colour temperature	Control	Product colours
[SYM] Symmetric - 118°	[700] 52 W	[827] 2700 K CRI 80	[ONOFF] On/Off	[HM1]  Black
		[830] 3000 K CRI 80	[DALI] DALI	[HM2]  Dark grey
		[740] 4000 K CRI 70	[AUTO] AutoDIM	[HM3]  Anthracite grey
		[840] 4000 K CRI 80	[STEP] StepDIM	[HM4]  Light grey
				[HM5]  White
				[HM6]  Bronze
				[CC]  Custom colour (Please specify RAL code)
Extras				
Consult the factory				
[UNI] 120-277V 50/60Hz				

Variant code	Light distribution	Delivered lumens flux	Rated input power	Colour temperature	Control
LP4075.844-EN-SYM-700-740	[SYM] Symmetric - 118°	4940 lm	52 W	4000 K CRI 70	On/Off, DALI, AutoDIM, StepDIM
LP4075.844-EN-SYM-700-827	[SYM] Symmetric - 118°	4035 lm	52 W	2700 K CRI 80	On/Off, DALI, AutoDIM, StepDIM
LP4075.844-EN-SYM-700-830	[SYM] Symmetric - 118°	4420 lm	52 W	3000 K CRI 80	On/Off, DALI, AutoDIM, StepDIM
LP4075.844-EN-SYM-700-840	[SYM] Symmetric - 118°	4490 lm	52 W	4000 K CRI 80	On/Off, DALI, AutoDIM, StepDIM