

TERRA Asym

LP4024.537-US

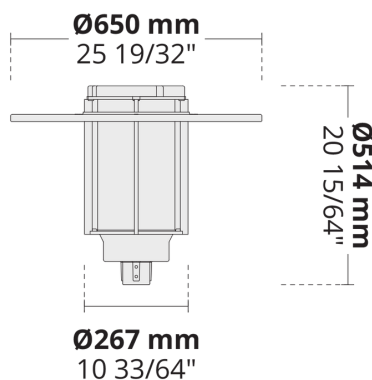

[ASYM-LE]
Asymmetric, Special
effect: Leaf -
107x109°

Configurations

Light distribution	[ASYM-LE] 107x109°
Delivered lumens flux	2366 - 2808 lm
Rated input power	28 W
Color temperature	2700 K CRI 80, 3000 K CRI 80, 4000 K CRI 70, 4000 K CRI 80
Lifetime L90 (hour)	>102,000
Lifetime L80 (hour)	>102,000

Options

Control	On/Off, 0-10V
Product colors	

Extras

External surge protection	10 kV
Luminaire body options	Double powder coating

Technical information

Mounting	Direct pole or side bracket mountable. Tenon: Ø2 1/4" x 4"
Housing	Corrosion resistant, marine grade aluminum housing
Finishing	Chromate conversion pretreatment followed by electrostatic powder coating
Fasteners	Stainless steel (AISI 304 / EN 1.4301 grade)
Gasket	EPDM gasket (Shore A 20-25)
Lens / Reflector	PMMA lens with high optical efficiency
Glass / Diffusor	Tempered safety glass
Impact protection	IK07
Ingress protection	IP65
Input voltage	120-277V 50/60Hz
Insulation class	Class I
Wind catching area (EPA)	1.07 ft²
Weight	15.4 lbs
LED module	High power LEDs on metal-core PCB
Driver	Internal LED driver
Driver surge protection	4/2 kV
Power factor	> 0.90
Through wiring	Single power cord entry
Operating temperature	-30...50°C
Power cord	20" of outdoor use rated flexible power cord

Poles (To be ordered separately)

Round tapered aluminum poles with base plate



Product code	Height	Diameter / Dimensions	Spigot / End diameter
PAFK.D114	10', 13.1', 16.4'	Ø4 1/2"	Ø2 3/8", Ø3"
PAFK.D122	13.1', 16.4', 19.7'	Ø5"	Ø2 3/8", Ø3"
PAFK.D148	19.7', 23.0', 26.2'	Ø6"	Ø2 3/8", Ø3"
PAFK.D165	19.7', 23.0', 26.2', 29.5'	Ø6 1/2"	Ø3 1/2", Ø3"
PAFK.D180	26.2', 29.5', 32.8'	Ø7"	Ø3 1/2", Ø3"
PAFK.D200	32.8', 36.1', 39.4'	Ø7 7/8"	Ø3 1/2", Ø3"

Round tapered aluminum poles (direct burial)



Product code	Height	Diameter / Dimensions	Spigot / End diameter
PABK.D114	10', 13.1', 16.4'	Ø4 1/2"	Ø2 3/8", Ø3"
PABK.D122	13.1', 16.4', 19.7', 23.0'	Ø5"	Ø2 3/8", Ø3"
PABK.D148	19.7', 23.0', 26.2'	Ø6"	Ø2 3/8", Ø3"
PABK.D165	19.7', 23.0', 26.2', 29.5'	Ø6 1/2"	Ø3 1/2", Ø3"
PABK.D180	26.2', 29.5', 32.8'	Ø7"	Ø3 1/2", Ø3"
PABK.D200	32.8', 36.1', 39.4'	Ø7 7/8"	Ø3 1/2", Ø3"







Round cylindrical aluminum poles with base plate



Product code	Height	Diameter / Dimensions	Spigot / End diameter
PAFC.D114	10', 13.1', 16.4'	Ø4 1/2"	Ø4 1/2"
PAFC.D122	10', 13.1', 16.4', 19.7'	Ø5"	Ø4 51/64"
PAFC.D148	19.7', 23.0', 26.2'	Ø6"	Ø5 7/8"
PAFC.D165	19.7', 23.0', 26.2', 29.5'	Ø6 1/2"	Ø6 1/2"

Project name		Type		Quantity	
Date		Note			

LP4024.537-US-____-____-____-____-____-____-____

Light distribution	Rated input power	Color temperature	Control	Product colors
[ASYM-LE] Asymmetric, Special effect: Leaf - 107x109°	[700] 28 W	[827] 2700 K CRI 80 [830] 3000 K CRI 80 [740] 4000 K CRI 70 [840] 4000 K CRI 80	[ONOFF] On/Off [0-10V] 0-10V	[HM1]  Black [HM2]  Dark gray [HM3]  Anthracite gray [HM4]  Light gray [HM5]  White [HM6]  Bronze [CC]  Custom color (Please specify RAL code)

Extras
External surge protection
[SP10] 10 kV
Luminaire body options
[DPC] Double powder coating

Configuration code	Light distribution	Delivered lumens flux	Rated input power	Color temperature	Control
LP4024.537-US-ASYM-LE-700-740	[ASYM-LE] Asymmetric, Special effect: Leaf - 107x109°	2808 lm	28 W	4000 K CRI 70	On/Off, 0-10V
LP4024.537-US-ASYM-LE-700-827	[ASYM-LE] Asymmetric, Special effect: Leaf - 107x109°	2366 lm	28 W	2700 K CRI 80	On/Off, 0-10V
LP4024.537-US-ASYM-LE-700-830	[ASYM-LE] Asymmetric, Special effect: Leaf - 107x109°	2366 lm	28 W	3000 K CRI 80	On/Off, 0-10V
LP4024.537-US-ASYM-LE-700-840	[ASYM-LE] Asymmetric, Special effect: Leaf - 107x109°	2366 lm	28 W	4000 K CRI 80	On/Off, 0-10V