

# TERRA Asym

LP4024.537-EN

CE UK CA IK07 IP65 

**heper**<sup>+</sup>

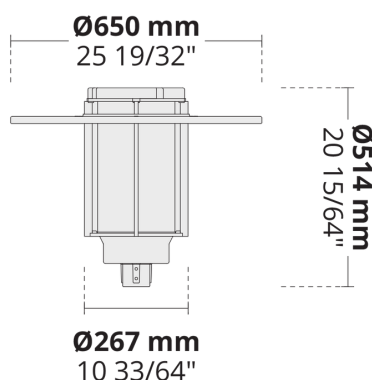

**[ASYM-LE]**  
Asymmetric, Special  
effect: Leaf -  
107x109°

## Variants

<b>Light distribution</b>	[ASYM-LE] 107x109°
<b>Delivered lumens flux</b>	2366 - 2808 lm
<b>Rated input power</b>	28 W
<b>Colour temperature</b>	2700 K CRI 80, 3000 K CRI 80, 4000 K CRI 70, 4000 K CRI 80
<b>Lifetime L90B50 (hour)</b>	>102,000
<b>Lifetime L80B50 (hour)</b>	>102,000

## Options

<b>Control</b>	On/Off, DALI, AutoDIM, StepDIM
<b>Product colours</b>	

## Extras

<b>External surge protection</b>	10 kV
<b>Light output</b>	Constant light output
<b>Consult the factory</b>	120-277V 50/60Hz
<b>Luminaire body options</b>	Double powder coating

## Technical information

<b>Mounting</b>	Direct pole or side bracket mountable. Spigot: Ø60 mm x 100 mm
<b>Housing</b>	Corrosion resistant, marine grade aluminum housing
<b>Finishing</b>	Chromate conversion pretreatment followed by electrostatic powder coating
<b>Fasteners</b>	Stainless steel (AISI 304 / EN 1.4301 grade)
<b>Gasket</b>	EPDM gasket (Shore A 20-25)
<b>Lens / Reflector</b>	PMMA lens with high optical efficiency
<b>Glass / Diffusor</b>	Tempered safety glass
<b>Impact protection</b>	IK07
<b>Ingress protection</b>	IP65
<b>Input voltage</b>	220-240V 50/60Hz
<b>Insulation class</b>	Class I
<b>Wind catching area (EPA)</b>	0.1 m <sup>2</sup>
<b>Weight</b>	7.02 kg
<b>LED module</b>	High power LEDs on metal-core PCB
<b>Driver</b>	Internal LED driver
<b>Driver surge protection</b>	10/6 kV
<b>Power factor</b>	> 0.95
<b>Through wiring</b>	Single cable entry
<b>Operating temperature</b>	-40...50°C
<b>Cable</b>	0.5 m of flexible cable

HPR Pazarlama A.Ş.  
Başkent OSB 22. Cd. No: 2, Malıköy, Temelli,  
Sincan, 06909 Ankara, Turkey  
+90 312 267 54 30  
info@hepergroup.com

HEPER Europe GmbH  
Ahornweg 5a, 58675  
Hemer, Germany  
+49 237 2901 2975  
infoEU@hepergroup.com

We reserve the right to change specifications  
without prior written notice. Edition: 23.02.2024.  
For current version visit [heperlighting.com](http://heperlighting.com). All  
flux (±%7 tolerance) and power values (±%10  
tolerance) are derived following appropriate IES,  
CIE, and applicable standards.

## Poles (To be ordered separately)

### Conical aluminum poles with flange plate

	Product code	Height	Diameter / Dimensions	Spigot diameter
	PAFK.D114	3m, 4m, 5m m	Ø114mm	Ø60mm, Ø76mm mm
	PAFK.D122	4m, 5m, 6m m	Ø122mm	Ø60mm, Ø76mm mm
	PAFK.D148	6m, 7m, 8m m	Ø148mm	Ø60mm, Ø76mm mm
	PAFK.D165	6m, 7m, 8m, 9m m	Ø165mm	Ø76mm, Ø90mm mm
	PAFK.D180	10m, 8m, 9m m	Ø180mm	Ø76mm, Ø90mm mm
	PAFK.D200	10m, 11m, 12m m	Ø200mm	Ø76mm, Ø90mm mm

### Conical aluminum poles with embedded base







	Product code	Height	Diameter / Dimensions	Spigot diameter
	PABK.D114	3m, 4m, 5m m	Ø114mm	Ø60mm, Ø76mm mm
	PABK.D122	4m, 5m, 6m, 7m m	Ø122mm	Ø60mm, Ø76mm mm
	PABK.D148	6m, 7m, 8m m	Ø148mm	Ø60mm, Ø76mm mm
	PABK.D165	6m, 7m, 8m, 9m m	Ø165mm	Ø76mm, Ø90mm mm
	PABK.D180	10m, 8m, 9m m	Ø180mm	Ø76mm, Ø90mm mm
	PABK.D200	10m, 11m, 12m m	Ø200mm	Ø76mm, Ø90mm mm

### Cylindrical aluminum poles with flange plate

	Product code	Height	Diameter / Dimensions	Spigot diameter
	PAFC.D114	3m, 4m, 5m m	Ø114mm	Ø114mm mm
	PAFC.D122	3m, 4m, 5m, 6m m	Ø122mm	Ø122mm mm
	PAFC.D148	6m, 7m, 8m m	Ø148mm	Ø148mm mm
	PAFC.D165	6m, 7m, 8m, 9m m	Ø165mm	Ø165mm mm

Project name		Type		Quantity	
Date		Note			

**LP4024.537-EN-**\_\_\_\_-\_\_\_\_-\_\_\_\_-\_\_\_\_-\_\_\_\_**-EN-C1-**\_\_\_\_-\_\_\_\_-\_\_\_\_-\_\_\_\_-\_\_\_\_

Light distribution	Rated input power	Colour temperature	Control	Product colours
<b>[ASYM-LE]</b> Asymmetric, Special effect: Leaf - 107x109°	<b>[700]</b> 28 W	<b>[827]</b> 2700 K CRI 80	<b>[ONOFF]</b> On/Off	<b>[HM1]</b>  Black
		<b>[830]</b> 3000 K CRI 80	<b>[DALI]</b> DALI	<b>[HM2]</b>  Dark grey
		<b>[740]</b> 4000 K CRI 70	<b>[AUTO]</b> AutoDIM	<b>[HM3]</b>  Anthracite grey
		<b>[840]</b> 4000 K CRI 80	<b>[STEP]</b> StepDIM	<b>[HM4]</b>  Light grey
				<b>[HM5]</b>  White
				<b>[HM6]</b>  Bronze
				<b>[CC]</b>  Custom colour (Please specify RAL code)

<b>Extras</b>
<b>External surge protection</b>
<b>[SP10]</b> 10 kV
<b>Light output</b>
<b>[CLO]</b> Constant light output
<b>Consult the factory</b>
<b>[UNI]</b> 120-277V 50/60Hz
<b>Luminaire body options</b>
<b>[DPC]</b> Double powder coating

Variant code	Light distribution	Delivered lumens flux	Rated input power	Colour temperature	Control
LP4024.537-EN-ASYM-LE-700-740	[ASYM-LE] Asymmetric, Special effect: Leaf - 107x109°	2808 lm	28 W	4000 K CRI 70	On/Off, DALI, AutoDIM, StepDIM
LP4024.537-EN-ASYM-LE-700-827	[ASYM-LE] Asymmetric, Special effect: Leaf - 107x109°	2366 lm	28 W	2700 K CRI 80	On/Off, DALI, AutoDIM, StepDIM
LP4024.537-EN-ASYM-LE-700-830	[ASYM-LE] Asymmetric, Special effect: Leaf - 107x109°	2366 lm	28 W	3000 K CRI 80	On/Off, DALI, AutoDIM, StepDIM
LP4024.537-EN-ASYM-LE-700-840	[ASYM-LE] Asymmetric, Special effect: Leaf - 107x109°	2366 lm	28 W	4000 K CRI 80	On/Off, DALI, AutoDIM, StepDIM