

TRIAN L AFX Mini

LL6020.895-EN

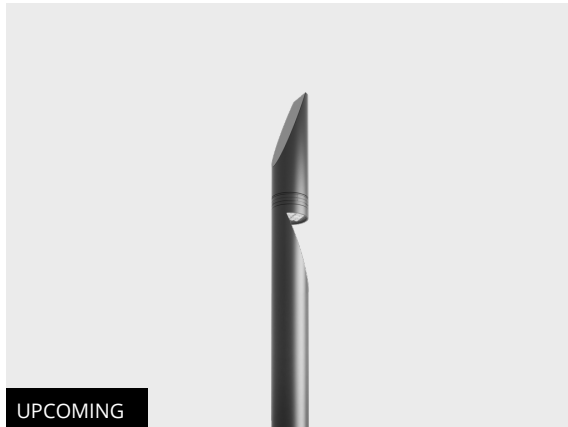

UPCOMING

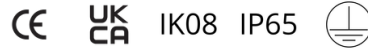
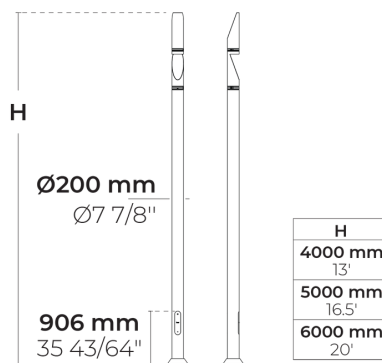

[T2-2]

Type II, Asymmetric,
Side throw - 134x52°

[T3]

Type III, Asymmetric,
Side throw - 131x60°

Variants

Light distribution	[T2-2] 134x52°, [T3] 131x60°
Delivered lumens flux	1695 - 3633 lm
Rated input power	12 - 26 W
Colour temperature	2200 K CRI 80, 2700 K CRI 80, 3000 K CRI 80, 4000 K CRI 70
BUG rating	B2-U2-G3
Lifetime L90B50 (hour)	>102, 000
Lifetime L80B50 (hour)	>102, 000, 004, 010, 001, 003, 002, 015, 016, 013, 014, 012, 009, 008, 023, 022, 021, 020, 019, 018, 017, 007, 006, 005, 011

Options

Control	On/Off, DALI, AutoDIM, StepDIM
Product colours	
Height	4m, 5m, 6m

Extras

External surge protection	10 kV
Light output	Constant light output
Consult the factory	Class II
Luminaire body options	Double powder coating

Technical information

Mounting	Surface mountable
Housing	Corrosion resistant, extruded, marine grade aluminum housing
Finishing	Chromate conversion pretreatment followed by electrostatic powder coating
Fasteners	Stainless steel (AISI 304 / EN 1.4301 grade)
Lens / Reflector	PMMA lens with high optical efficiency
Glass / Diffusor	Tempered safety glass
Impact protection	IK08
Ingress protection	IP65
Input voltage	220-240V 50/60Hz
Insulation class	Class I
Weight	48.5kg(4m) , 56.2kg(6m) , 64kg(6m)
LED module	High power LEDs on metal-core PCB
Driver	Internal LED driver
Driver surge protection	10/6 kV
Power factor	> 0.95
Through wiring	Single cable entry
Operating temperature	-40...50°C
Cable	0.5 m of flexible cable

Accessories (To be ordered separately)

Anchorage

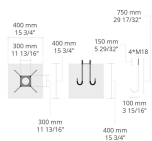

90DJ006

90DJ006

Anchorage

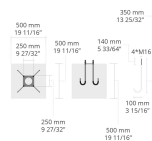







90CJ004

90CJ004

Project name		Type		Quantity	
Date		Note			

LL6020.895-EN-____-____-____-____**-EN-C1-**____-____-____-____-____-____

Light distribution	Rated input power	Colour temperature	Control	Product colours
[T2-2] Type II, Asymmetric, Side throw - 134x52° [T3] Type III, Asymmetric, Side throw - 131x60°	[350] 12 W [500] 18 W [700] 26 W	[822] 2200 K CRI 80 [827] 2700 K CRI 80 [830] 3000 K CRI 80 [740] 4000 K CRI 70	[ONOFF] On/Off [DALI] DALI [AUTO] AutoDIM [STEP] StepDIM	[HM1]  Black [HM2]  Dark grey [HM3]  Anthracite grey [HM4]  Light grey [HM5]  White [HM6]  Bronze [CC]  Custom colour (Please specify RAL code)

Height	Extras	Accessories (<i>To be ordered separately</i>)
[H4] 4m [H5] 5m [H6] 6m	External surge protection	Anchorage
	[SP10] 10 kV	[90D]006] 90D]006
	Light output	[90C]004] 90C]004
	[CLO] Constant light output	
	Consult the factory	
	[C2] Class II	
	Luminaire body options	
	[DPC] Double powder coating	

Variant code	Light distribution	Delivered lumens flux	Rated input power	Colour temperature	Control
LL6020.895-EN-T3-350-740	[T3] Type III, Asymmetric, Side throw - 131x60°	1973 lm	12 W	4000 K CRI 70	On/Off
LL6020.895-EN-T3-350-822	[T3] Type III, Asymmetric, Side throw - 131x60°	1714 lm	12 W	2200 K CRI 80	On/Off
LL6020.895-EN-T3-350-827	[T3] Type III, Asymmetric, Side throw - 131x60°	1930 lm	12 W	2700 K CRI 80	On/Off
LL6020.895-EN-T3-350-830	[T3] Type III, Asymmetric, Side throw - 131x60°	1959 lm	12 W	3000 K CRI 80	On/Off
LL6020.895-EN-T3-500-740	[T3] Type III, Asymmetric, Side throw - 131x60°	2711 lm	18 W	4000 K CRI 70	On/Off
LL6020.895-EN-T3-500-822	[T3] Type III, Asymmetric, Side throw - 131x60°	2320 lm	18 W	2200 K CRI 80	On/Off
LL6020.895-EN-T3-500-827	[T3] Type III, Asymmetric, Side throw - 131x60°	2551 lm	18 W	2700 K CRI 80	On/Off
LL6020.895-EN-T3-500-830	[T3] Type III, Asymmetric, Side throw - 131x60°	2691 lm	18 W	3000 K CRI 80	On/Off
LL6020.895-EN-T3-700-740	[T3] Type III, Asymmetric, Side throw - 131x60°	3633 lm	26 W	4000 K CRI 70	On/Off
LL6020.895-EN-T3-700-822	[T3] Type III, Asymmetric, Side throw - 131x60°	2992 lm	26 W	2200 K CRI 80	On/Off
LL6020.895-EN-T3-700-827	[T3] Type III, Asymmetric, Side throw - 131x60°	3419 lm	26 W	2700 K CRI 80	On/Off
LL6020.895-EN-T3-700-830	[T3] Type III, Asymmetric, Side throw - 131x60°	3419 lm	26 W	3000 K CRI 80	On/Off
LL6020.895-EN-T2-2-350-740	[T2-2] Type II, Asymmetric, Side throw - 134x52°	2058 lm	12 W	4000 K CRI 70	On/Off
LL6020.895-EN-T2-2-350-822	[T2-2] Type II, Asymmetric, Side throw - 134x52°	1695 lm	12 W	2200 K CRI 80	On/Off
LL6020.895-EN-T2-2-350-827	[T2-2] Type II, Asymmetric, Side throw - 134x52°	1937 lm	12 W	2700 K CRI 80	On/Off
LL6020.895-EN-T2-2-350-830	[T2-2] Type II, Asymmetric, Side throw - 134x52°	1937 lm	12 W	3000 K CRI 80	On/Off
LL6020.895-EN-T2-2-500-740	[T2-2] Type II, Asymmetric, Side throw - 134x52°	2786 lm	18 W	4000 K CRI 70	On/Off
LL6020.895-EN-T2-2-500-822	[T2-2] Type II, Asymmetric, Side throw - 134x52°	2294 lm	18 W	2200 K CRI 80	On/Off
LL6020.895-EN-T2-2-500-827	[T2-2] Type II, Asymmetric, Side throw - 134x52°	2622 lm	18 W	2700 K CRI 80	On/Off
LL6020.895-EN-T2-2-500-830	[T2-2] Type II, Asymmetric, Side throw - 134x52°	2622 lm	18 W	3000 K CRI 80	On/Off
LL6020.895-EN-T2-2-700-740	[T2-2] Type II, Asymmetric, Side throw - 134x52°	3592 lm	26 W	4000 K CRI 70	On/Off
LL6020.895-EN-T2-2-700-822	[T2-2] Type II, Asymmetric, Side throw - 134x52°	2958 lm	26 W	2200 K CRI 80	On/Off
LL6020.895-EN-T2-2-700-827	[T2-2] Type II, Asymmetric, Side throw - 134x52°	3381 lm	26 W	2700 K CRI 80	On/Off
LL6020.895-EN-T2-2-700-830	[T2-2] Type II, Asymmetric, Side throw - 134x52°	3381 lm	26 W	3000 K CRI 80	On/Off

HPR Pazarlama A.Ş.

Başkent OSB 22. Cd. No: 2, Malıköy, Temelli,
Sincan, 06909 Ankara, Turkey
+90 312 267 54 30
info@hepergroup.com

HEPER Europe GmbH

Ahornweg 5a, 58675
Hemer, Germany
+49 237 2901 2975
infoEU@hepergroup.com

We reserve the right to change specifications without prior written notice. Edition: 29.03.2024.
For current version visit heperlighting.com. All flux (±%7 tolerance) and power values (±%10 tolerance) are derived following appropriate IES, CIE, and applicable standards.