

SPARK Zoom

LF8041.529-EN

CE UK CA IK07 IP66

heper

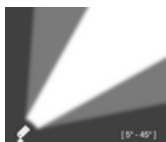
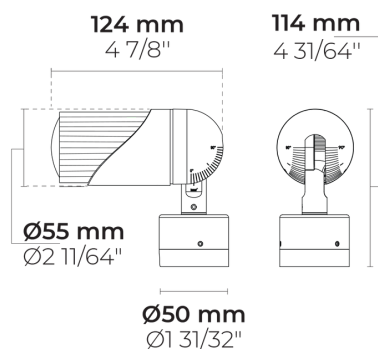
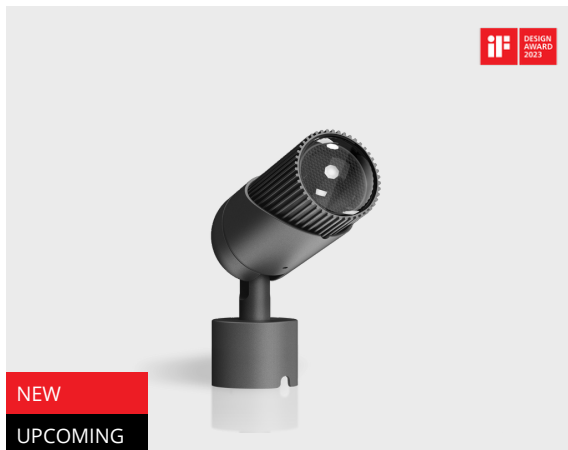

[Z]
Zoom - 5°-45°

Variants

Light distribution	[Z] 5°-45°
Delivered lumens flux	174 - 215 lm
Rated input power	5 W
Colour temperature	2700 K CRI 90, 3000 K CRI 80, 3000 K CRI 90
Lifetime L90B50 (hour)	>102000
Lifetime L80B50 (hour)	>102000

Options

Product colours



Extras

Mounting options	Wall Mount
Luminaire body options	Double powder coating

Technical information

Mounting	Surface mountable via a stationary base (standard), spike and wall-mountable via a bracket (both optional)
Tilt angle	+90°/0°
Rotation angle	0°/+355°
Housing	Corrosion resistant, marine grade aluminum housing
Finishing	Knurled surface in black anodized aluminum and body in chromate conversion pretreatment followed by electrostatic powder coating
Fasteners	Stainless steel (AISI 316L)
Gasket	EPDM gasket (Shore A 25-30)
Lens / Reflector	PMMA lens with high optical efficiency
Glass / Diffuser	Tempered safety glass
Impact protection	IK07
Ingress protection	IP66
Input voltage	12 Vdc (Max) 350 mA
Insulation class	Class III
Weight	0.43 kg
LED module	High power LEDs on metal-core PCB
Driver	External LED driver
Through wiring	Single cable entry
Operating temperature	-40...50°C
Cable	0.2 m of flexible cable

HPR Pazarlama A.Ş.
Başkent OSB 22. Cd. No: 2, Malıköy, Temelli,
Sincan, 06909 Ankara, Turkey
+90 312 267 54 30
info@hepergroup.com

HEPER Europe GmbH
Ahornweg 5a, 58675
Hemer, Germany
+49 237 2901 2975
infoEU@hepergroup.com

We reserve the right to change specifications without prior written notice. Edition: 29.03.2024. For current version visit heperlighting.com. All flux ($\pm 7\%$ tolerance) and power values ($\pm 10\%$ tolerance) are derived following appropriate IES, CIE, and applicable standards.

Accessories (To be ordered separately)

Mounting accessories

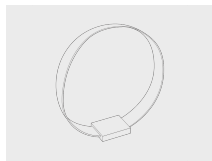

**Tree belt for
SPARK**

180901194

Mounting accessories

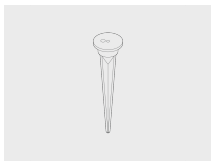

Spike

160405040







Mounting accessories



**DALI & On/Off
driver within an
IP67 box for
SPARK S**

007502876

Project name		Type		Quantity	
Date		Note			
LF8041.529-EN-__-__-__-__-CC-12V-350-C3-__-__-__					

Light distribution	Rated input power	Colour temperature	Control	Product colours
[Z] Zoom - 5°-45°	[350] 5 W	[927] 2700 K CRI 90 [830] 3000 K CRI 80 [930] 3000 K CRI 90		[HM1]  Black [HM2]  Dark grey [HM3]  Anthracite grey [HM4]  Light grey [HM5]  White [HM6]  Bronze [CC]  Custom colour (Please specify RAL code)

Extras	Accessories (<i>To be ordered separately</i>)
Mounting options	Mounting accessories
[WM] Wall Mount	[180901194] Tree belt for SPARK
Luminaire body options	[160405040] Spike
[DPC] Double powder coating	[007502876] DALI & On/Off driver within an IP67 box for SPARK S

Variant code	Light distribution	Delivered lumens flux	Rated input power	Colour temperature	Control
LF8041.529-EN-Z-350-830	[Z] Zoom - 5°-45°	215 lm	5 W	3000 K CRI 80	On/Off
LF8041.529-EN-Z-350-927	[Z] Zoom - 5°-45°	174 lm	5 W	2700 K CRI 90	On/Off
LF8041.529-EN-Z-350-930	[Z] Zoom - 5°-45°	186 lm	5 W	3000 K CRI 90	On/Off