

# REGIO V2 IN N 3 Module

LF8039.540-EN

CE UK CA IK08 IP66 

**heper**<sup>+</sup>

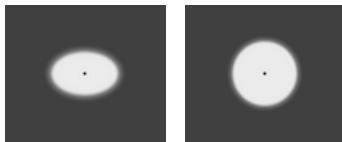
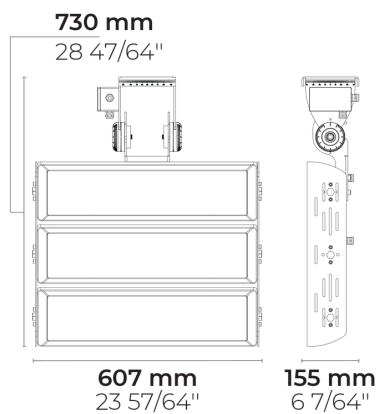

[EL]  
Elliptical - 20x30°

[N]  
Narrow - 15°

## Variants

<b>Light distribution</b>	[EL] 20x30°, [N] 15°
<b>Delivered lumens flux</b>	154513 - 205572 lm
<b>Rated input power</b>	1480 W
<b>Colour temperature</b>	2700 K CRI 80, 3000 K CRI 80, 4000 K CRI 70, 4000 K CRI 80, 5700 K CRI 90
<b>Lifetime L90B50 (hour)</b>	>52,000
<b>Lifetime L80B50 (hour)</b>	>52,000

## Options

<b>Control</b>	DALI
<b>Product colours</b>	  

## Extras

<b>Consult the factory</b>	120-277V 50/60Hz
----------------------------	------------------

## Technical information

<b>Mounting</b>	Direct tray mountable
<b>Tilt angle</b>	90°
<b>Rotation angle</b>	±63°
<b>Housing</b>	Corrosion resistant, die-cast, marine grade aluminum housing
<b>Finishing</b>	Chromate conversion pretreatment followed by electrostatic powder coating
<b>Fasteners</b>	Stainless steel (AISI 304 / EN 1.4301 grade)
<b>Gasket</b>	Silicone
<b>Glass / Diffuser</b>	Tempered safety glass
<b>Impact protection</b>	IK08
<b>Ingress protection</b>	IP66
<b>Input voltage</b>	220-240V 50/60Hz
<b>Insulation class</b>	Class I
<b>Weight</b>	27.1 kg
<b>Driver</b>	External LED driver
<b>Driver surge protection</b>	10/6 kV
<b>Power factor</b>	> 0.99
<b>Through wiring</b>	Single cable entry
<b>Operating temperature</b>	-40...50°C
<b>Cable</b>	1 m of flexible cable

## Accessories (To be ordered separately)

---

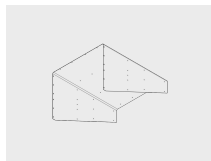

### Optical accessories



### Visor for REGIO V2 3 Module

100139032

Project name		Type		Quantity	
Date		Note			
<b>LF8039.540-EN-__-__-__-__-EN-C1-__-__</b>					

Light distribution	Rated input power	Colour temperature	Control	Product colours
<b>[EL]</b> Elliptical - 20x30°  <b>[N]</b> Narrow - 15°	<b>[1453]</b> 1480 W	<b>[827]</b> 2700 K CRI 80  <b>[830]</b> 3000 K CRI 80  <b>[740]</b> 4000 K CRI 70  <b>[840]</b> 4000 K CRI 80  <b>[957]</b> 5700 K CRI 90	<b>[DALI]</b> DALI	<b>[HM3]</b>  Anthracite grey  <b>[HM4]</b>  Light grey  <b>[CC]</b>  Custom colour (Please specify RAL code)
<b>Extras</b>	<b>Accessories (<i>To be ordered separately</i>)</b>			
<b>Consult the factory</b>	<b>Optical accessories</b>			
<b>[UNI]</b> 120-277V 50/60Hz	<b>[100139032]</b> Visor for REGIO V2 3 Module			

Variant code	Light distribution	Delivered lumens flux	Rated input power	Colour temperature	Control
LF8039.540-EN-N-1453-740	[N] Narrow - 15°	201767 lm	1480 W	4000 K CRI 70	On/Off, DALI
LF8039.540-EN-N-1453-827	[N] Narrow - 15°	169230 lm	1480 W	2700 K CRI 80	On/Off, DALI
LF8039.540-EN-N-1453-830	[N] Narrow - 15°	169230 lm	1480 W	3000 K CRI 80	On/Off, DALI
LF8039.540-EN-N-1453-840	[N] Narrow - 15°	183945 lm	1480 W	4000 K CRI 80	On/Off, DALI
LF8039.540-EN-N-1453-957	[N] Narrow - 15°	154513 lm	1480 W	5700 K CRI 90	On/Off, DALI
LF8039.540-EN-EL-1453-740	[EL] Elliptical - 20x30°	205572 lm	1480 W	4000 K CRI 70	On/Off, DALI
LF8039.540-EN-EL-1453-827	[EL] Elliptical - 20x30°	176020 lm	1480 W	2700 K CRI 80	On/Off, DALI
LF8039.540-EN-EL-1453-830	[EL] Elliptical - 20x30°	175973 lm	1480 W	3000 K CRI 80	On/Off, DALI
LF8039.540-EN-EL-1453-840	[EL] Elliptical - 20x30°	191326 lm	1480 W	4000 K CRI 80	On/Off, DALI
LF8039.540-EN-EL-1453-957	[EL] Elliptical - 20x30°	160714 lm	1480 W	5700 K CRI 90	On/Off, DALI