

REGIO V2 IN N 2 Module

LF8039.520-EN

CE UK CA IK08 IP66 



Variants

Light distribution	[EL] 20x30°, [N] 15°
Delivered lumens flux	81426 - 107048 lm
Rated input power	780 W
Colour temperature	2700 K CRI 80, 3000 K CRI 80, 4000 K CRI 70, 4000 K CRI 80, 5700 K CRI 90
Lifetime L90B50 (hour)	>52,000
Lifetime L80B50 (hour)	>52,000

Options

Control	DALI
Product colours	  

Extras

Consult the factory	120-277V 50/60Hz
----------------------------	------------------

Technical information

Mounting	Direct tray mountable
Tilt angle	90°
Rotation angle	±63°
Housing	Corrosion resistant, die-cast, marine grade aluminum housing
Finishing	Chromate conversion pretreatment followed by electrostatic powder coating
Fasteners	Stainless steel (AISI 304 / EN 1.4301 grade)
Gasket	Silicone
Glass / Diffuser	Tempered safety glass
Impact protection	IK08
Ingress protection	IP66
Input voltage	220-240V 50/60Hz
Insulation class	Class I
Weight	19.0 kg
Driver	External LED driver
Driver surge protection	10/6 kV
Power factor	> 0.99
Through wiring	Single cable entry
Operating temperature	-40...50°C
Cable	1 m of flexible cable

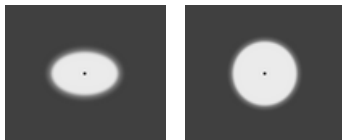
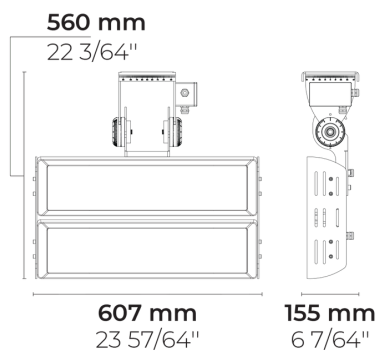

[EL]
Elliptical - 20x30°

[N]
Narrow - 15°

Accessories (To be ordered separately)

Optical accessories

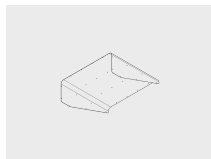



Visor for REGIO V2 2 Module

100139031

Project name		Type		Quantity	
Date		Note			

LF8039.520-EN-__-__-__-__-EN-C1-__-__

Light distribution	Rated input power	Colour temperature	Control	Product colours
[EL] Elliptical - 20x30° [N] Narrow - 15°	[2170] 780 W	[827] 2700 K CRI 80 [830] 3000 K CRI 80 [740] 4000 K CRI 70 [840] 4000 K CRI 80 [957] 5700 K CRI 90	[DALI] DALI	[HM3]  Anthracite grey [HM4]  Light grey [CC]  Custom colour (Please specify RAL code)
Extras	Accessories (<i>To be ordered separately</i>)			
Consult the factory	Optical accessories			
[UNI] 120-277V 50/60Hz	[100139031] Visor for REGIO V2 2 Module			

Variant code	Light distribution	Delivered lumens flux	Rated input power	Colour temperature	Control
LF8039.520-EN-N-2170-740	[N] Narrow - 15°	106448 lm	780 W	4000 K CRI 70	On/Off, DALI
LF8039.520-EN-N-2170-827	[N] Narrow - 15°	83067 lm	780 W	2700 K CRI 80	On/Off, DALI
LF8039.520-EN-N-2170-830	[N] Narrow - 15°	89196 lm	780 W	3000 K CRI 80	On/Off, DALI
LF8039.520-EN-N-2170-840	[N] Narrow - 15°	96911 lm	780 W	4000 K CRI 80	On/Off, DALI
LF8039.520-EN-N-2170-957	[N] Narrow - 15°	81426 lm	780 W	5700 K CRI 90	On/Off, DALI
LF8039.520-EN-EL-2170-740	[EL] Elliptical - 20x30°	107048 lm	780 W	4000 K CRI 70	On/Off, DALI
LF8039.520-EN-EL-2170-827	[EL] Elliptical - 20x30°	84789 lm	780 W	2700 K CRI 80	On/Off, DALI
LF8039.520-EN-EL-2170-830	[EL] Elliptical - 20x30°	91139 lm	780 W	3000 K CRI 80	On/Off, DALI
LF8039.520-EN-EL-2170-840	[EL] Elliptical - 20x30°	99104 lm	780 W	4000 K CRI 80	On/Off, DALI
LF8039.520-EN-EL-2170-957	[EL] Elliptical - 20x30°	83237 lm	780 W	5700 K CRI 90	On/Off, DALI