

URBAN BOLLARD Ch Asym

LB6061.548-US

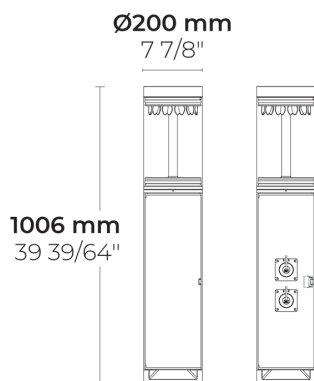

[ASYM]
Asymmetric -
102x45°

Configurations

Light distribution	[ASYM] 102x45°
Delivered lumens flux	1048 - 1235 lm
Rated input power	15 W
Color temperature	2700 K CRI 80, 3000 K CRI 80, 4000 K CRI 70, 4000 K CRI 80
BUG rating	B2-U0-G1
Lifetime L90 (hour)	>60, 000
Lifetime L80 (hour)	>60, 000

Options

Control	On/Off
Product colors	
Height	3.3'

Extras

Luminaire body options	Double powder coating
-------------------------------	-----------------------

Technical information

Mounting	Surface mountable
Housing	Corrosion resistant, extruded, marine grade aluminum housing
Finishing	Chromate conversion pretreatment followed by electrostatic powder coating
Fasteners	Stainless steel (AISI 304 / EN 1.4301 grade)
Gasket	Silicone
Lens / Reflector	High reflectance aluminium coating, multifaceted micro reflector
Glass / Diffusor	UV stable, bio-based polycarbonate diffusor
Impact protection	IK08
Ingress protection	IP65
Input voltage	120-277V 50/60Hz
Insulation class	Class I
Weight	26 lbs
LED module	Multi-chip high power LEDs on metal-core PCB
Driver	Internal LED driver
Driver surge protection	2/2 kV
Power factor	> 0.90
Through wiring	Single power cord entry
Operating temperature	-40...50°C
Power cord	20" of outdoor use rated flexible power cord
Notes	As standard, 2 sockets of mono-phase are provided. Upon request, a maximum of 3 sockets with different socket types can be also provided.

Accessories (To be ordered separately)

Anchor bolts

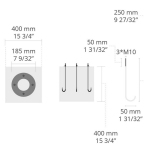







630J014

630J014

Project name		Type		Quantity	
Date		Note			

LB6061.548-US-____-____-____-____-____-____-____-____

Light distribution	Rated input power	Color temperature	Control	Product colors
[ASYM] Asymmetric - 102x45°	[350] 15 W	[827] 2700 K CRI 80 [830] 3000 K CRI 80 [740] 4000 K CRI 70 [840] 4000 K CRI 80	[ONOFF] On/Off	[HM1]  Black [HM2]  Dark gray [HM3]  Anthracite gray [HM4]  Light gray [HM5]  White [HM6]  Bronze [CC]  Custom color (Please specify RAL code)
Height	Extras	Accessories (<i>To be ordered separately</i>)		
[H1] 3.3' [HC]	Luminaire body options [DPC] Double powder coating	Anchor bolts [630]014] 630J014		

Configuration code	Light distribution	Delivered lumens flux	Rated input power	Color temperature	Control
LB6061.548-US-ASYM-350-740	[ASYM] Asymmetric - 102x45°	1235 lm	15 W	4000 K CRI 70	On/Off
LB6061.548-US-ASYM-350-827	[ASYM] Asymmetric - 102x45°	1048 lm	15 W	2700 K CRI 80	On/Off
LB6061.548-US-ASYM-350-830	[ASYM] Asymmetric - 102x45°	1064 lm	15 W	3000 K CRI 80	On/Off
LB6061.548-US-ASYM-350-840	[ASYM] Asymmetric - 102x45°	1118 lm	15 W	4000 K CRI 80	On/Off