

URBAN BOLLARD Ch Asym

LB6061.548-EN

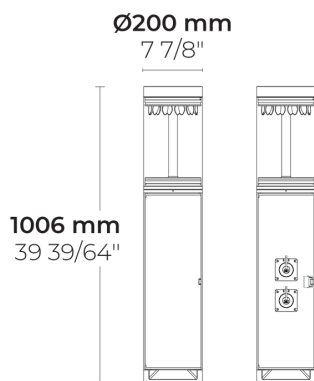

IK08 IP65



[ASYM]
Asymmetric -
102x45°

Variants

Light distribution	[ASYM] 102x45°
Delivered lumens flux	1048 - 1235 lm
Rated input power	15 W
Colour temperature	2700 K CRI 80, 3000 K CRI 80, 4000 K CRI 70, 4000 K CRI 80
BUG rating	B2-U0-G1
Lifetime L90B50 (hour)	>60, 000
Lifetime L80B50 (hour)	>60, 000

Options

Control	On/Off
Product colours	
Height	1m,

Extras

Consult the factory	120-277V 50/60Hz
Luminaire body options	Double powder coating

Technical information

Mounting	Surface mountable
Housing	Corrosion resistant, extruded, marine grade aluminum housing
Finishing	Chromate conversion pretreatment followed by electrostatic powder coating
Fasteners	Stainless steel (AISI 304 / EN 1.4301 grade)
Gasket	Silicone
Lens / Reflector	High reflectance aluminium coating, multifaceted micro reflector
Glass / Diffusor	UV stable, bio-based polycarbonate diffusor
Impact protection	IK08
Ingress protection	IP65
Input voltage	220-240V 50/60Hz
Insulation class	Class I
Weight	11.8 kg
LED module	Multi-chip high power LEDs on metal-core PCB
Driver	Internal LED driver
Driver surge protection	2/2 kV
Power factor	> 0.90
Through wiring	Single cable entry
Operating temperature	-40...50°C
Cable	0.5 m of flexible cable
Notes	As standard, 2 sockets of mono-phase are provided. Upon request, a maximum of 3 sockets with different socket types can be also provided.

Accessories (To be ordered separately)

Anchorage

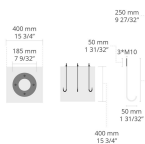







630J014

630J014

Project name		Type		Quantity	
Date		Note			

LB6061.548-EN-____-____-____-____**-EN-C1-**____-____-____-____

Light distribution	Rated input power	Colour temperature	Control	Product colours
[ASYM] Asymmetric - 102x45°	[350] 15 W	[827] 2700 K CRI 80 [830] 3000 K CRI 80 [740] 4000 K CRI 70 [840] 4000 K CRI 80	[ONOFF] On/Off	[HM1]  Black [HM2]  Dark grey [HM3]  Anthracite grey [HM4]  Light grey [HM5]  White [HM6]  Bronze [CC]  Custom colour (Please specify RAL code)
Height	Extras	Accessories (<i>To be ordered separately</i>)		
[H1] 1m	Consult the factory	Anchorage		
[HC]	[UNI] 120-277V 50/60Hz	[630]014] 630J014		
	Luminaire body options			
	[DPC] Double powder coating			

Variant code	Light distribution	Delivered lumens flux	Rated input power	Colour temperature	Control
LB6061.548-EN-ASYM-350-740	[ASYM] Asymmetric - 102x45°	1235 lm	15 W	4000 K CRI 70	On/Off
LB6061.548-EN-ASYM-350-827	[ASYM] Asymmetric - 102x45°	1048 lm	15 W	2700 K CRI 80	On/Off
LB6061.548-EN-ASYM-350-830	[ASYM] Asymmetric - 102x45°	1064 lm	15 W	3000 K CRI 80	On/Off
LB6061.548-EN-ASYM-350-840	[ASYM] Asymmetric - 102x45°	1118 lm	15 W	4000 K CRI 80	On/Off