

HEPER USA LLC

W227 N546 Westmound Drive Waukesha, 53186
Wisconsin, United States
+1 312 910 9740
infoUS@hepergroup.com

GOLEDO-T 160 LED (LT2037.880-US)

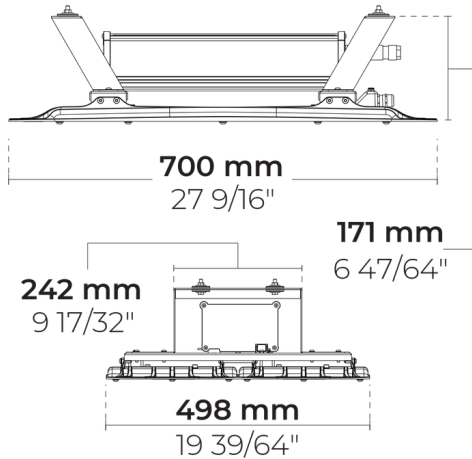

41.34 lbs

<https://heperlighting.com/us/lt2037.880-us/>

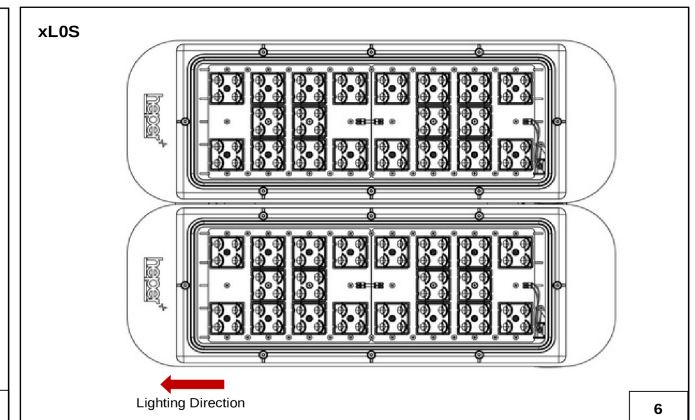
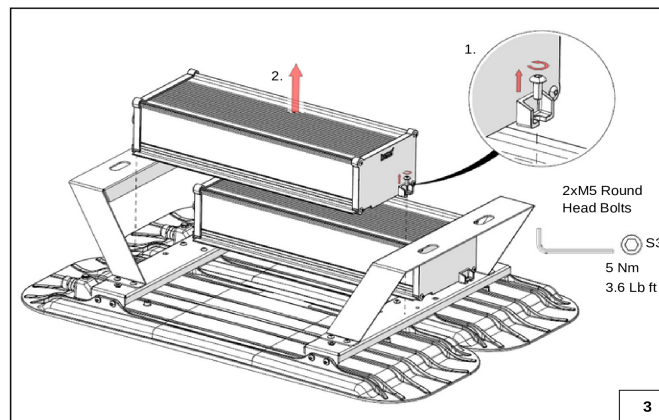
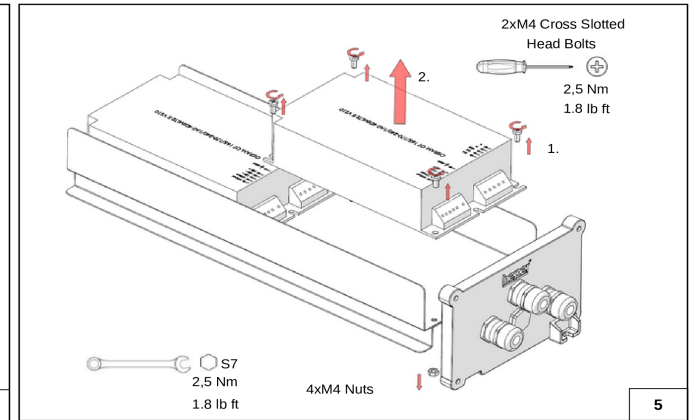
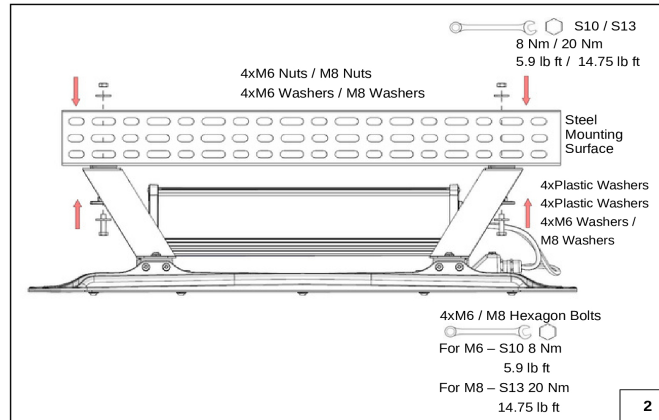
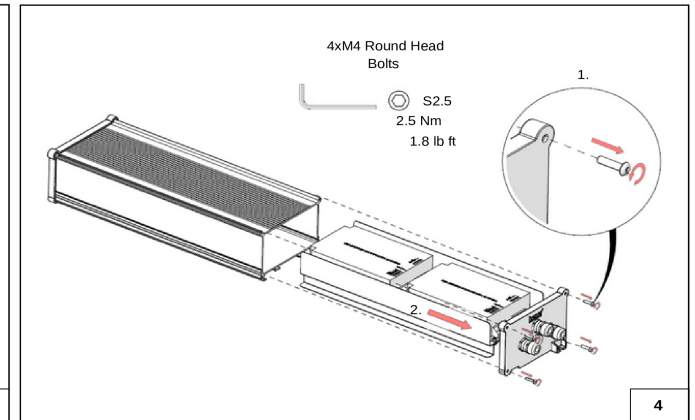
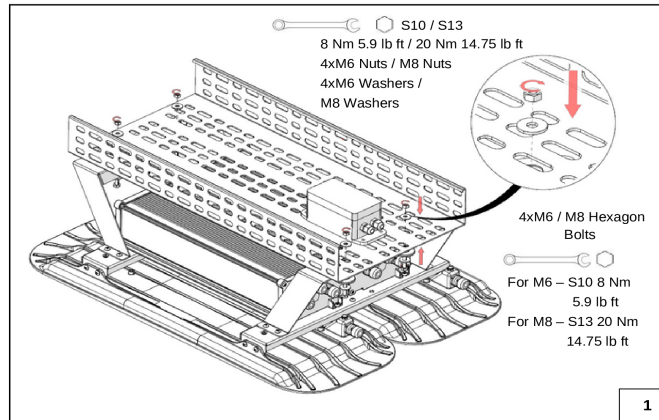

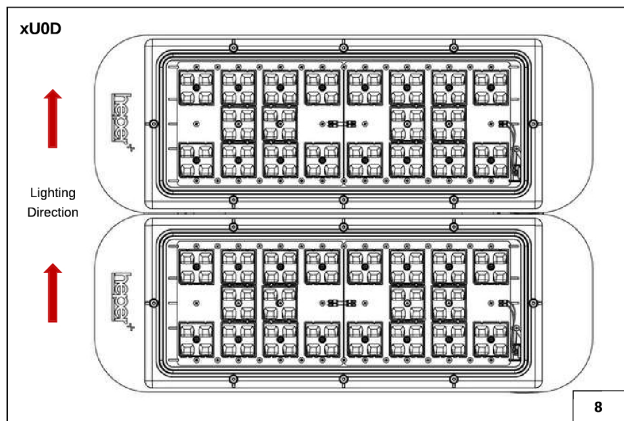
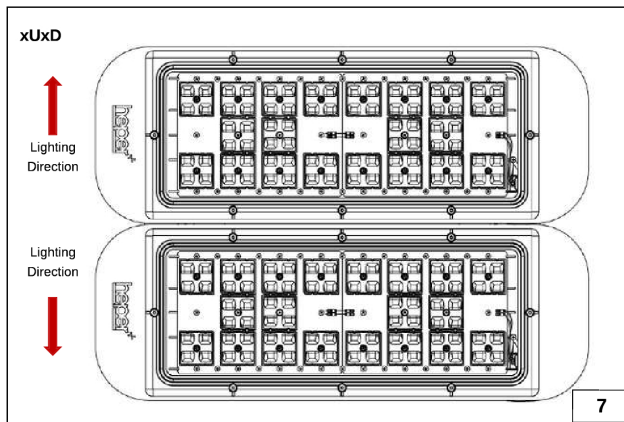

Safety



- The product must be installed in accordance with applicable NEC standards by a qualified electrician familiar with the installation of exterior lighting fixtures.



- The product must be operated under specified voltage at all times.



- Do not install if parts are damaged.



- Power must be disconnected while installing or servicing to avoid electrical shock.



- Failing to comply with warnings and installation steps in this document might void warranty.



- Do not touch the light source.

- Make sure that temperature of the product is at a safe level before touching.

- Do not allow cables to touch sharp edges of metal parts or other sharp objects to avoid damage or abrasion.



- Check all of the cable connections including grounding before powering the product.

- Check the proper grounding of the metal housing before powering the product.

- Only use the product for its intended purposes.



- Do not use accessories not approved or recommended by HEPER.

- Weight of the luminaire: 18.75kg / 41.3 lbs (160 LED)

- The luminaire should be positioned at a distance of less than 6.2m, in a position that does not allow long-term gaze.

- Maximum mounting height: 9,6m / 31,5ft

- If any external cable of this luminaire is damaged, it should be exclusively replaced by the manufacturer or his service agent or a similar qualified person in order to avoid a hazard.

- The light source of the luminaire and any other components related with the luminaire should only be replaced by manufacturer, service agent or a similar qualified person.

- Since the product is provided with supply cable, the terminal block to be used shall be approved according to IEC/EN 60998-2-1 standard. Rated current and voltage of the terminal are 3A (min) and 220-240 VAC and it needs to be placed inside of a IP 66 rated box.



- Replace any broken/cracked protective surface with a new one



- The luminaire should be positioned so that prolonged staring into the luminaire at a distance <2m is not expected



- Do not stare at the operating light source.

Installation

- The surface on which the product will be mounted must be flat and level

- The product should be mounted, with the related types of equipment as shown in the visual.

- Terminal block is not included. Installation must be performed by a qualified person/electrician.

- The red arrow shows the lighting direction. Please consider your layout before installation!

Replacement of the control gear

- To release the driver box from luminaire, screws should be removed as shown on the visual.

- To reach to the driver, pull the driver box like drawer after unscrewing screws as shown on the visual.

- To detach the driver from the plate unscrew the screws as shown on the visual.

Cleaning - Maintenance

- The product was designed and manufactured to operate for a long period of time. To ensure maximum lifespan of the product, regular (i.e. every six months) visual inspection and cleaning with a solvent-free cleaner using a soft cloth is recommended.

- Do not clean or service while the product is power connected.

Disposal



- In accordance with EU Directive WEEE (Waste Electrical and Electronic Equipment), luminaires must not be disposed of with other household waste. At the end of their life, luminaires must be taken to the appropriate local facility available for the disposal or recycling of electronic products.

Wiring Color Codes

- Ground - GREEN

- Line - BLACK

- Neutral - WHITE

- Dim(+) - RED/PURPLE

- Dim (-) - GRAY/ORANGE

Disclaimer

- HEPER reserve the right to make technical and design changes.