

HEPER USA LLC

W227 N546 Westmound Drive Waukesha, 53186
Wisconsin, United States
+1 312 910 9740
infoUS@hepergroup.com

MINIKA 4x90° (LR9014.515-4x90-US)

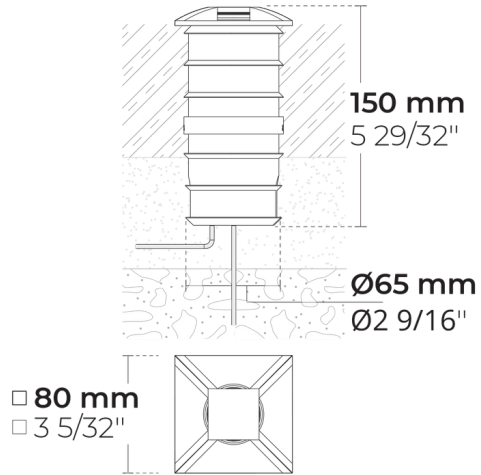

1.45 lbs

<https://heperlighting.com/us/lr9014.515-4x90-us/>

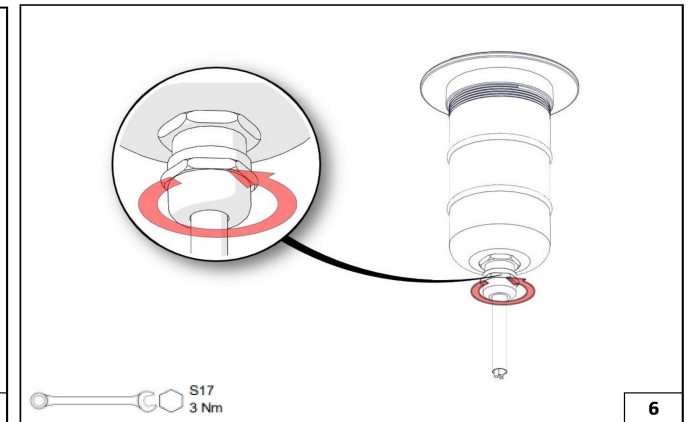
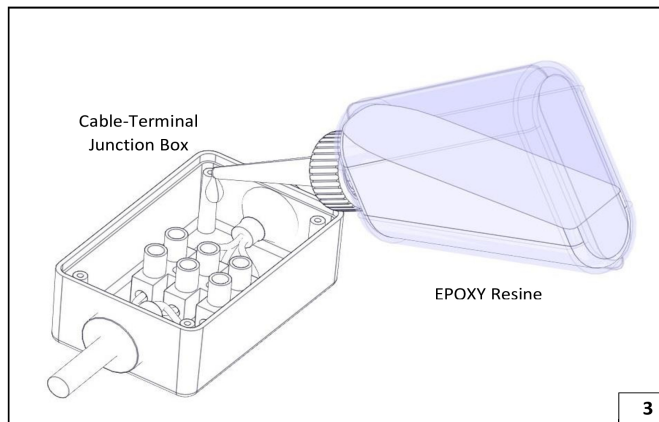
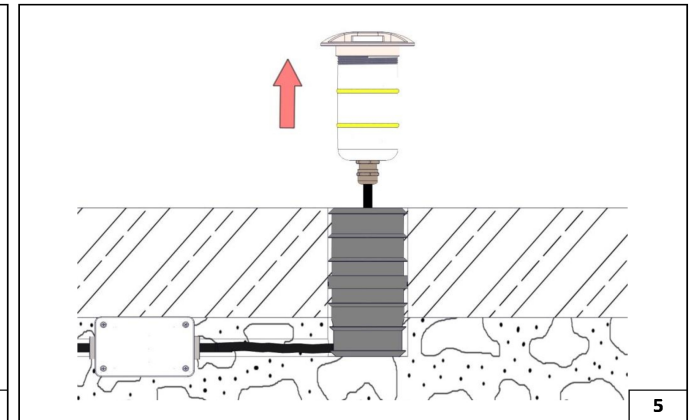
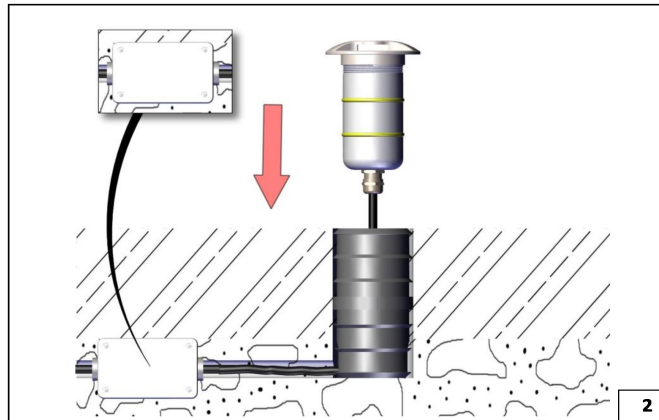
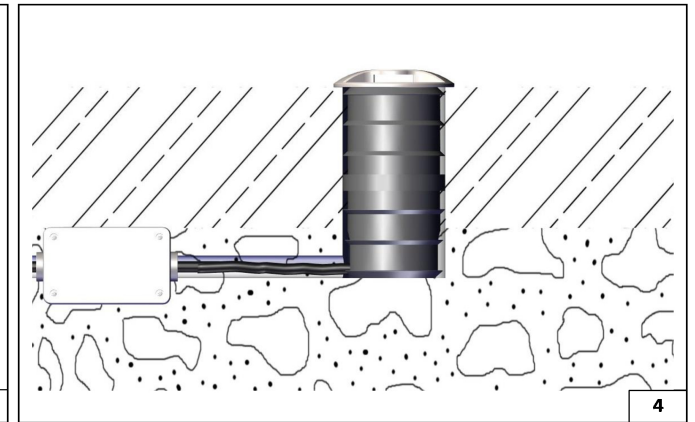
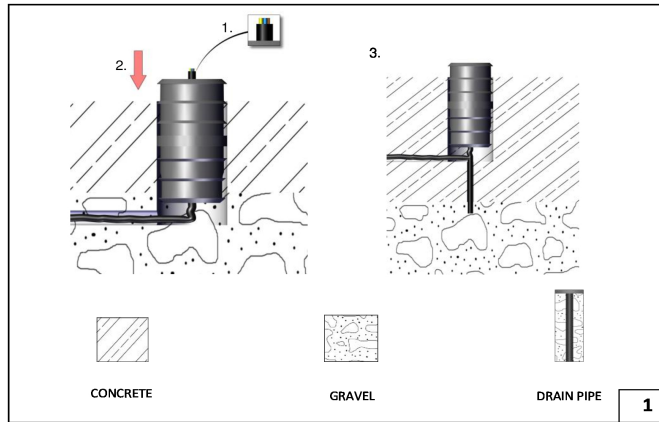

Safety



- The product must be installed in accordance with applicable NEC standards by a qualified electrician familiar with the installation of exterior lighting fixtures.



- The product must be operated under specified voltage at all times.



- Do not install if parts are damaged.



- Power must be disconnected while installing or servicing to avoid electrical shock.



- Failing to comply with warnings and installation steps in this document might void warranty.



- Do not touch the light source.

- Make sure that temperature of the product is at a safe level before touching.

- Do not allow cables to touch sharp edges of metal parts or other sharp objects to avoid damage or abrasion.



- Check all of the cable connections including grounding before powering the product.

- Check the proper grounding of the metal housing before powering the product.

- Only use the product for its intended purposes.



- Do not use accessories not approved or recommended by HEPER.

- Installation of inground luminaires shouldn't be done during periods of excessive rain.



- The product is suitable for walk-over with a maximum load of 200 kg.



- Replace any broken/cracked protective surface with a new one

Installation

- Please note that, sleeves/cases are ordered separately from the luminaire.

- Install pea gravel below luminaire to provide drainage. If the luminaire will be completely encased in concrete or a substrate that has questionable drainage, then the use of a drainage pipe to re-direct rain or water flowing into the luminaire is required

- Prepare cavity and be sure that certain conduit and power supply cable are accessible and have ample slack to make appropriate connections.

- Install the luminaire into prepared cavity.

- Utilize appropriate IP 68 or NEMA-rated box and fittings to make all

electrical connections. Note: IP 68 or NEMA-rated box and epoxy resin are not provided with the product.

Cleaning - Maintenance

- The product was designed and manufactured to operate for a long period of time. To ensure maximum lifespan of the product, regular (i.e. every six months) visual inspection and cleaning with a solvent-free cleaner using a soft cloth is recommended.

- Do not clean or service while the product is power connected.

Disposal



- In accordance with EU Directive WEEE (Waste Electrical and Electronic Equipment), luminaires must not be disposed of with other household waste. At the end of their life, luminaires must be taken to the appropriate local facility available for the disposal or recycling of electronic products.

Wiring Color Codes

- Ground - GREEN

- Line - BLACK

- Neutral - WHITE

- Dim(+) - RED/PURPLE

- Dim (-) - GRAY/ORANGE

Disclaimer

- HEPER reserve the right to make technical and design changes.