

HEPER USA LLC

W227 N546 Westmound Drive Waukesha, 53186
Wisconsin, United States
+1 312 910 9740
infoUS@hepergroup.com

DOMINO ML EVO 1 Module Duo (LP4091.681-US)

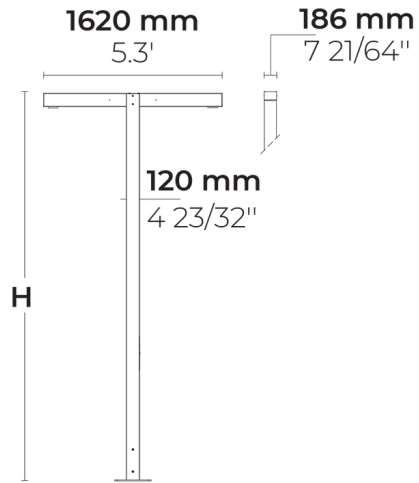

110.77 lbs (13'), 121.99 lbs (16.5'), 133.21 lbs (20')

<https://heperlighting.com/us/lp4091.681-us/>

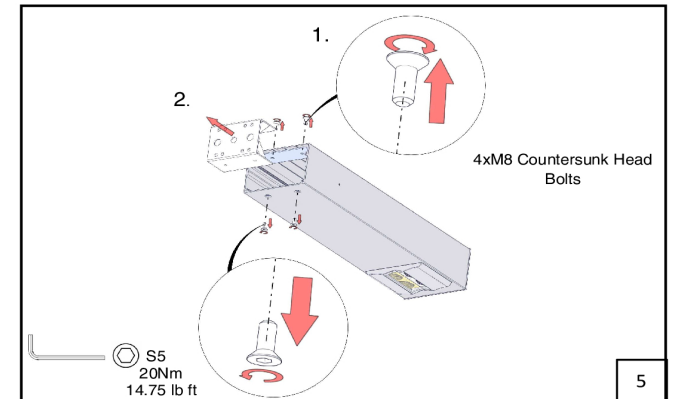
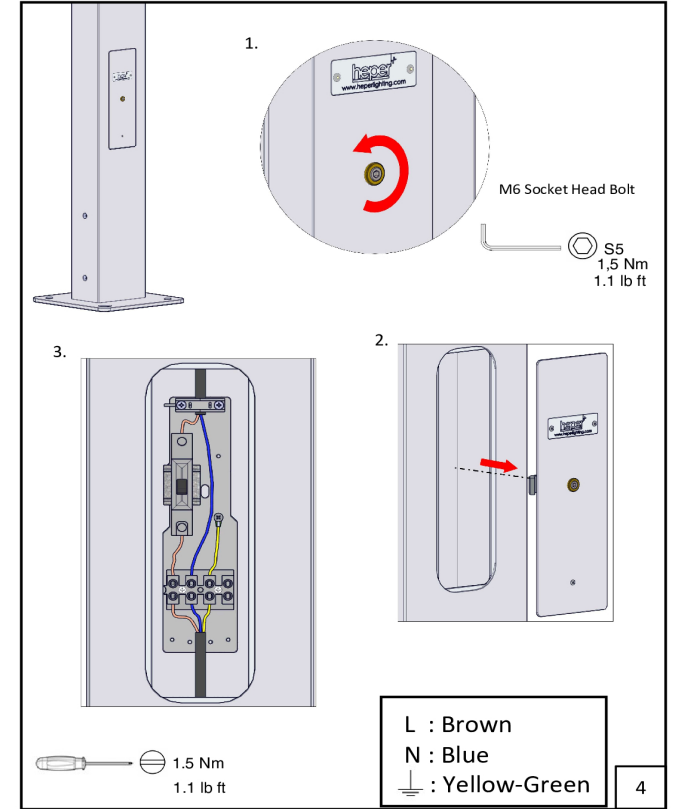
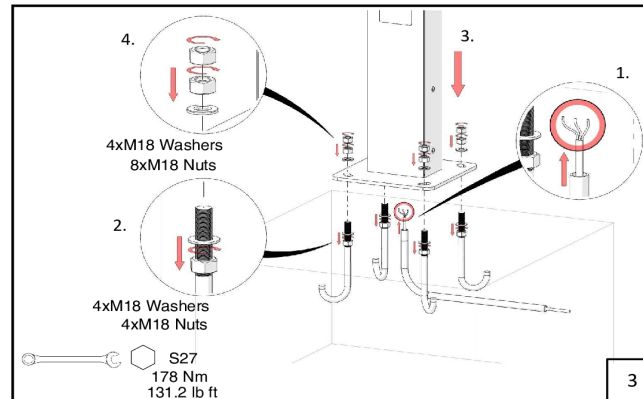
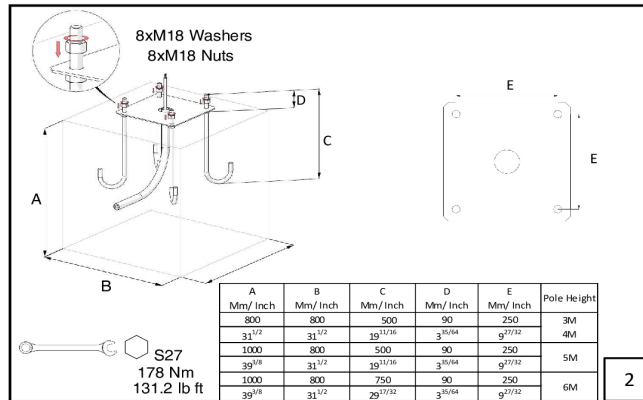
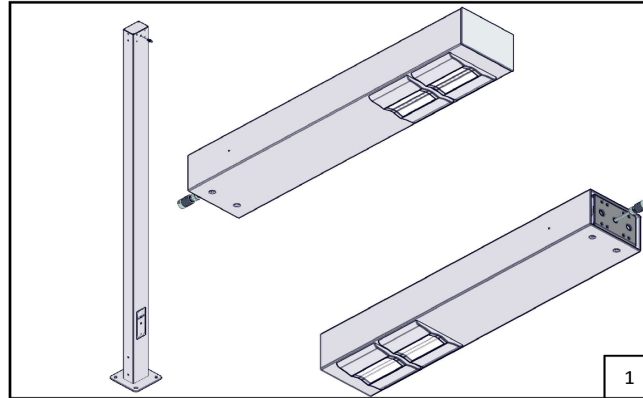

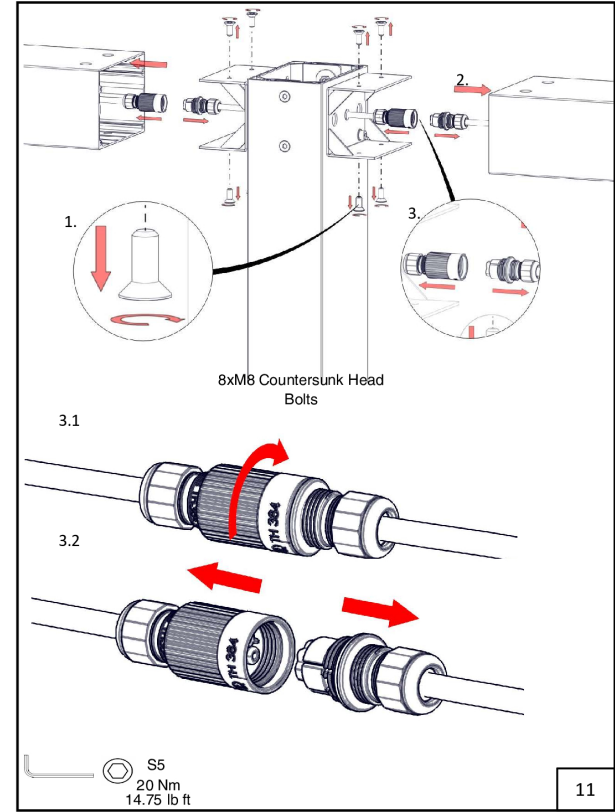
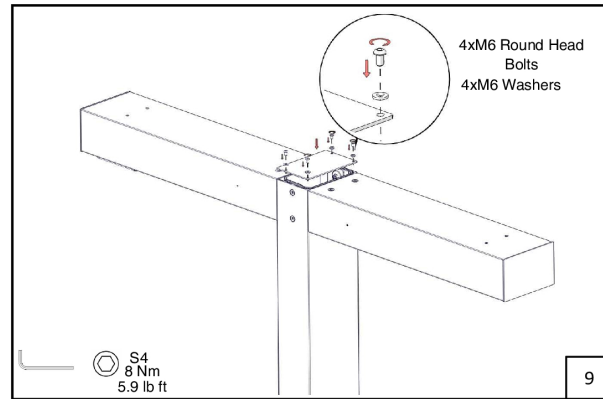
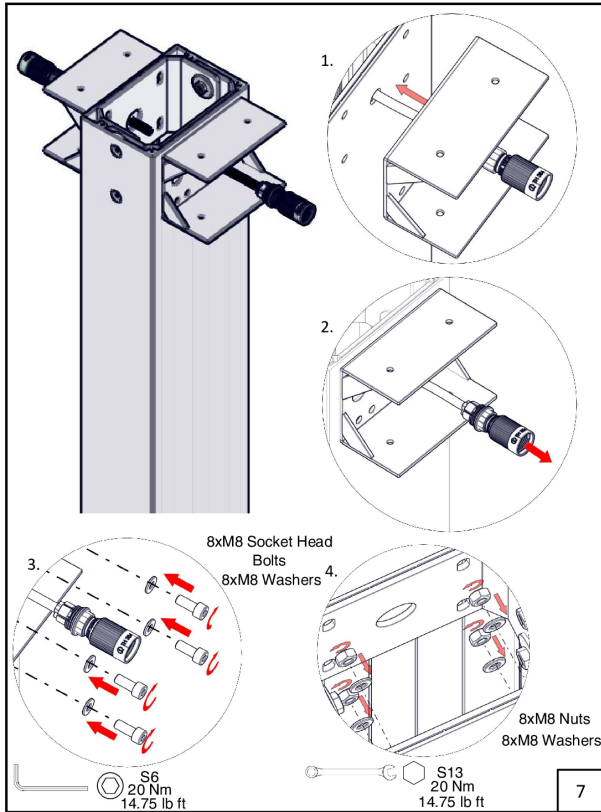
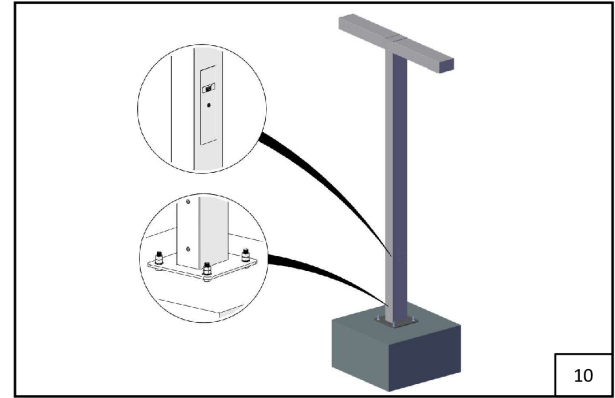
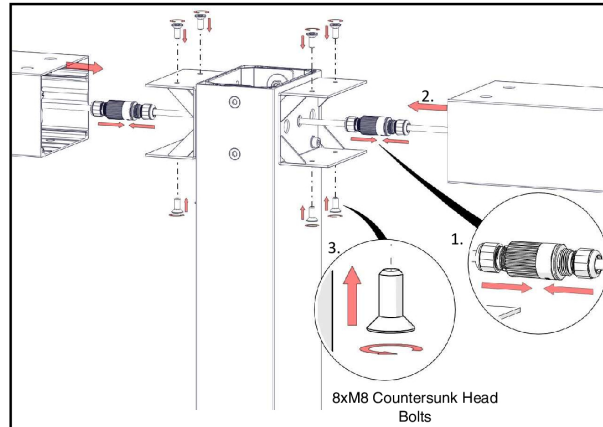
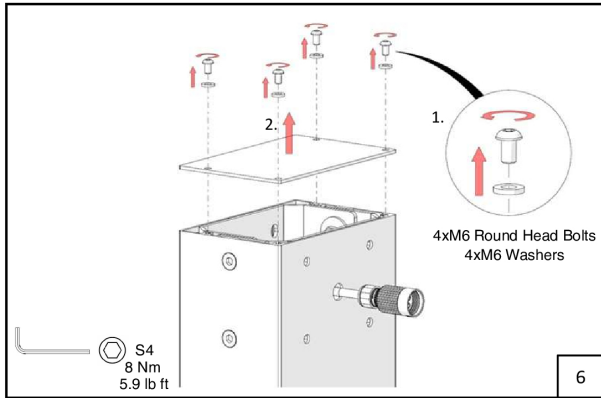

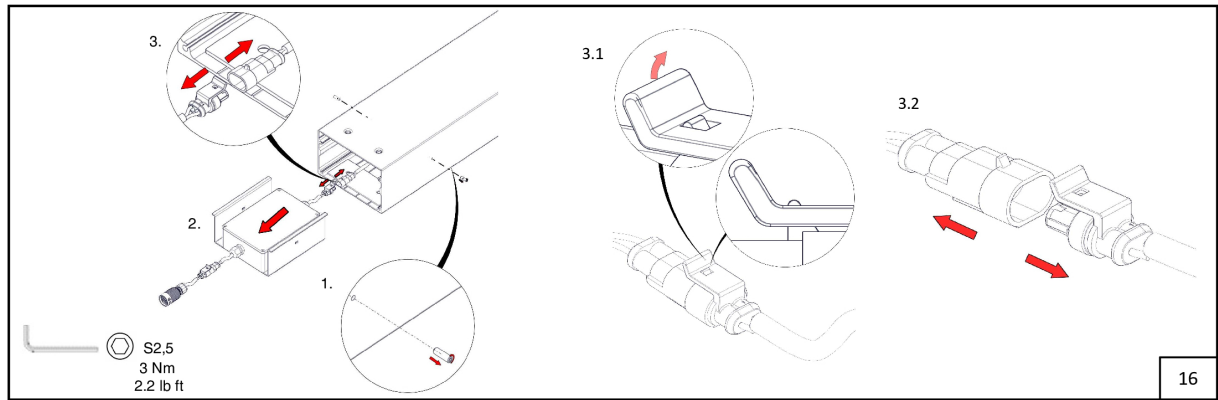
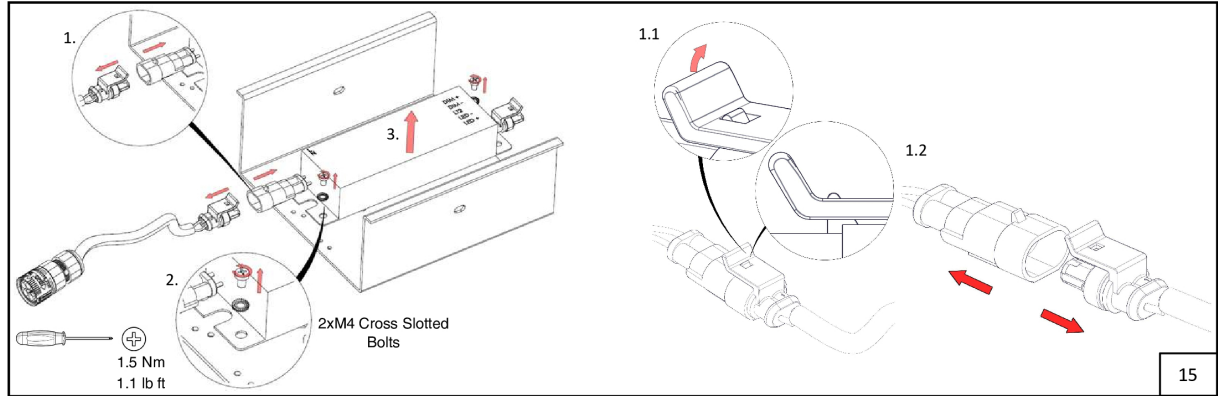
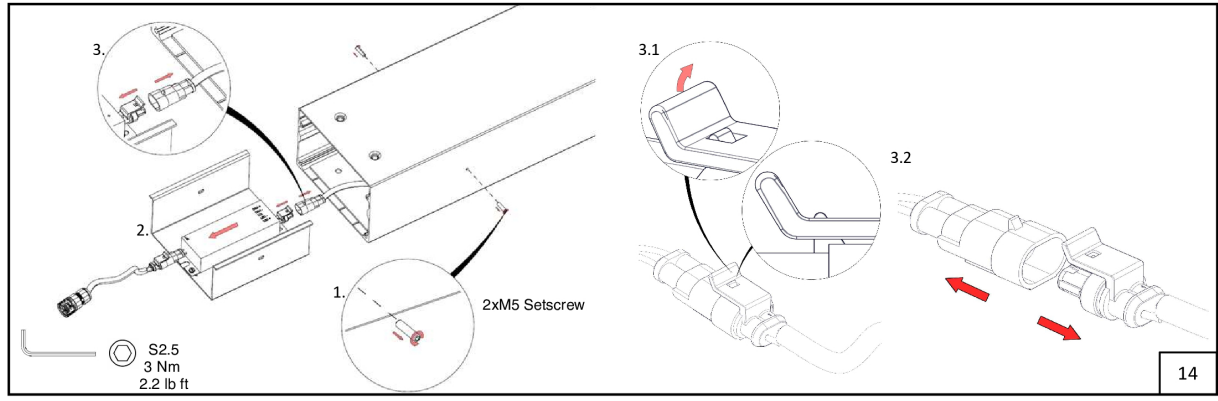
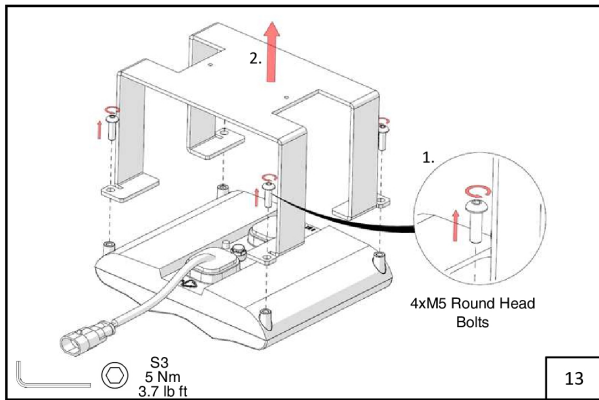
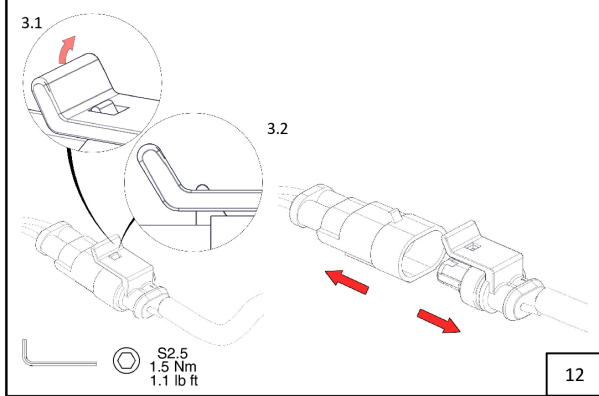
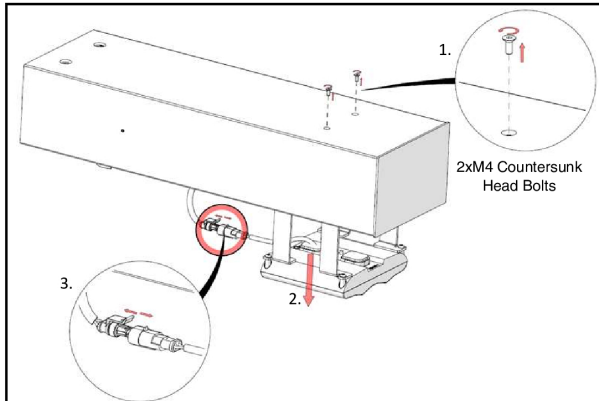

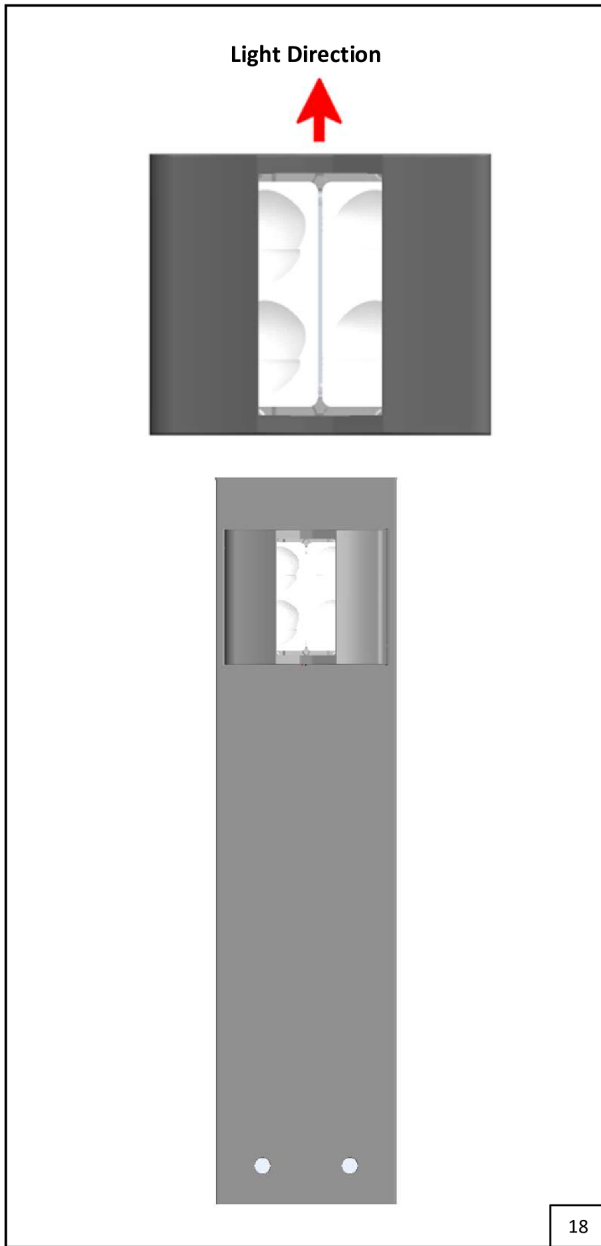
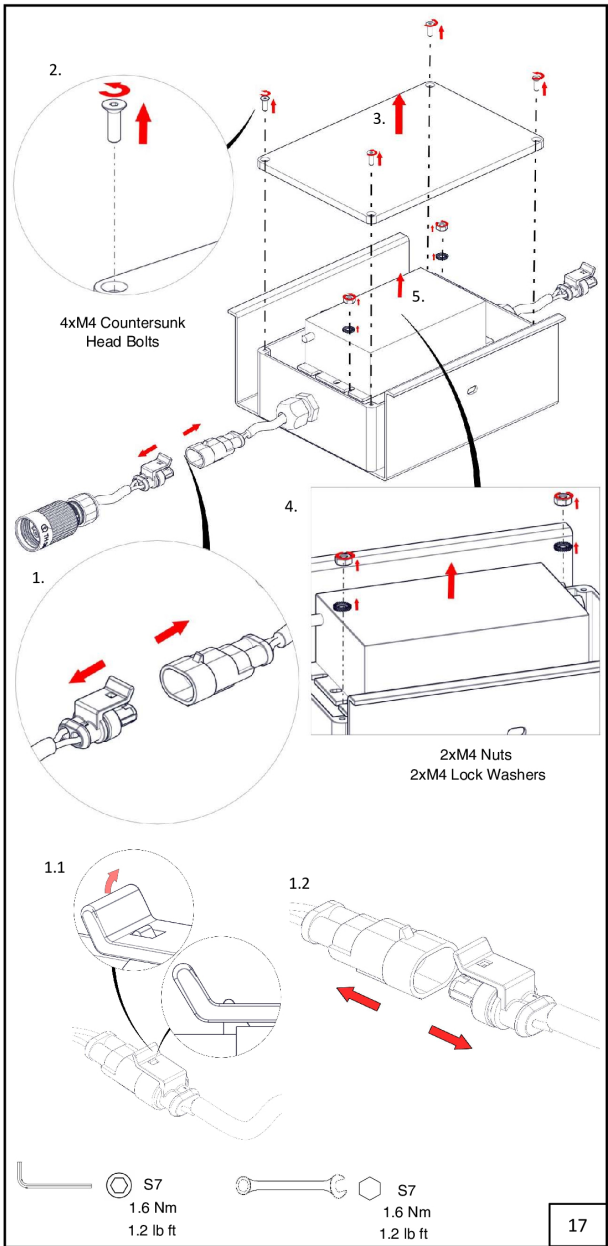

Safety



- The product must be installed in accordance with applicable NEC standards by a qualified electrician familiar with the installation of exterior lighting fixtures.



- The product must be operated under specified voltage at all times.



- Do not install if parts are damaged.



- Power must be disconnected while installing or servicing to avoid electrical shock.



- Failing to comply with warnings and installation steps in this document might void warranty.



- Do not touch the light source.

- Make sure that temperature of the product is at a safe level before touching.

- Do not allow cables to touch sharp edges of metal parts or other sharp objects to avoid damage or abrasion.



- Check all of the cable connections including grounding before powering the product.

- Check the proper grounding of the metal housing before powering the product.

- Only use the product for its intended purposes.



- Do not use accessories not approved or recommended by HEPER.



- Replace any broken/cracked protective surface with a new one

Installation

- The surface on which the product will be mounted must be flat and level

- Assemble the product base using the provided or appropriate hardware.

- Open the holes on the surface as shown in the visual.

- Place the base of the product centered onto the concrete base and secure the bolts as shown on the visual.

- To assemble the product, use IP 68 rated connector.

- Make the external power line connection as shown on the visual.

- Disassemble the bolts from the product head. Make the mounting plate connection of the product to the pole as shown in the visual.

- Make the connector connection as shown in the visual. After that, assemble the product head on the pole as shown and screw the pole top cover.

Replacement of the light source

- Disconnect the power coming into the product.

- Remove the light source from the head and unscrew it from the backplate.

- Reinstall the product following the same steps.

Replacement of the control gear

- Disconnect the power coming into the product.

- Remove the plate to gain access to the driver location.

- Unscrew the driver holder from the housing to be able to pull it out from the product.

- Detach the driver and place the new one.

- Reinstall the product following the same steps.

- The completed product installation should be as shown on the visual.

Cleaning - Maintenance

- The product was designed and manufactured to operate for a long period of time. To ensure maximum lifespan of the product, regular (i.e. every six months) visual inspection and cleaning with a solvent-free cleaner using a soft cloth is recommended.

- Do not clean or service while the product is power connected.

Disposal



- In accordance with EU Directive WEEE (Waste Electrical and Electronic Equipment), luminaires must not be disposed of with other household waste. At the end of their life, luminaires must be taken to the appropriate local facility available for the disposal or recycling of electronic products.

Wiring Color Codes

- Ground - GREEN

- Line - BLACK

- Neutral - WHITE

- Dim(+) - RED/PURPLE

- Dim (-) - GRAY/ORANGE

Disclaimer

- HEPER reserve the right to make technical and design changes.